

This problem is intended to familiarize you with one of the basic switching dc-to-dc converters--the buck converter (Fig. 1), fundamentals of its operation, assumptions usually made and practical limitations.

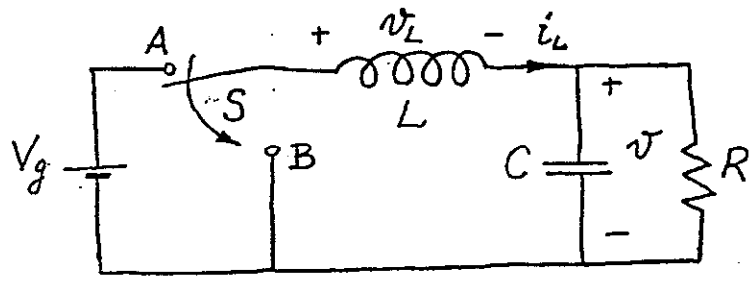

Fig. 1 Buck Switching dc-to-dc Converter

switched

Switch S is periodically for interval  $DT_s$  in position A and for interval  $D'T_s \equiv (1-D) T_s$  in position B, where  $f_s \triangleq 1/T_s$  is the switching frequency and D is defined as switch duty ratio.

- I. Let  $C = 0$ 
  - a. After a large number of cycles the inductor current becomes periodic and the steady-state is established as shown in Fig. 2. From the fundamental differential equations determine exactly the current levels  $I_1$  and  $I_2$  characterizing this steady state.
  - b. By assuming that  $R/L \ll f_s$  in your answer to part (a) find the average inductor current  $I_L$  and determine an approximation to the inductor current ripple  $\Delta i_L \triangleq I_2 - I_1$ .
  - c. Obtain an expression for the relative magnitude of the output voltage switching ripple  $\Delta V/V$ .

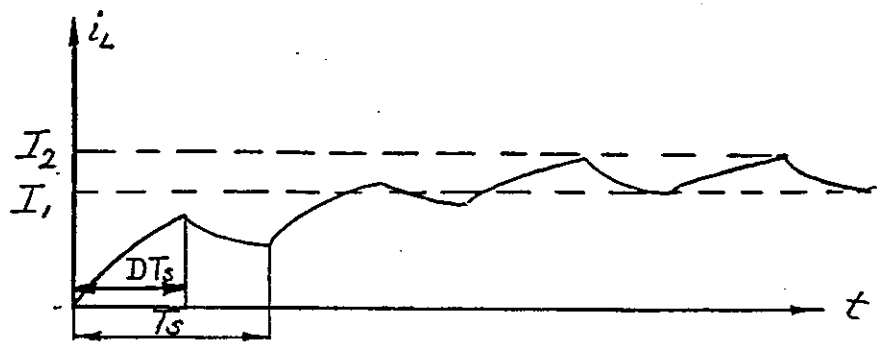

Fig. 2 Inductor Current Waveform

| P.T.O

## POWER ELECTRONICS

II. Let  $C \neq 0$ .

- a. Assuming that the output voltage switching ripple  $\Delta v$  is small compared to its dc value  $V$ , derive an approximation for its relative magnitude  $\Delta v/V$ . Hint: assume that  $L$  sees only the dc component of  $v$ , that is  $V$ , whereas  $C$  sees only the ac component of  $i_L$ .

III. Find and compare the values of  $L$  required to make  $\frac{\Delta V}{V} = 0.0025$  (or 0.25%) for two cases: (a)  $C = 0$ ; (b)  $C = 10 \mu\text{F}$ . Use the following parameters and justify the approximations:

$$V_g = 15 \text{ V}, \quad V = 7.5 \text{ V}, \quad T_s = 50 \mu\text{sec}, \quad R = 100 \text{ ohm}.$$

IV. The ideal switch  $S$  in Fig. 1 is now realized by the transistor, diode configuration as shown in Fig. 3. Assume that the transistor can be modelled in saturation by a constant voltage source  $V_s = 0.5 \text{ V}$ , and diode by a constant voltage source  $V_F = 1.0 \text{ V}$  in its on state, while they have infinite resistance in their off states. Assume also that the converter operates in the continuous conduction mode (inductor current never falls to zero).

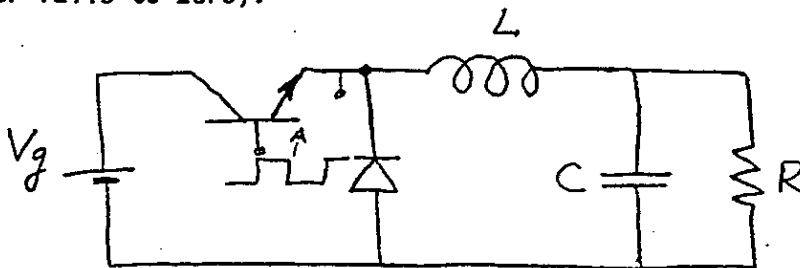

Fig. 3 Practical Implementation of Buck Converter

- a. Find an expression for <sup>output</sup> voltage  $V = f_1(D, V_s, V_F, V_g)$
- b. Find an expression for the efficiency  $\eta = f_2(V, D, V_s, V_F)$  and put it in the form  $\eta = f_3(V_g, V_s, V_F) f_4(V, V_F)$
- c. Using the results of part (a) and (b) calculate the efficiency  $\eta$  for the following cases:

$$V_g = 15 \text{ V}, \quad V = 7.5 \text{ V}; \quad V_g = 90 \text{ V}, \quad V = 15 \text{ V}; \quad V_g = 15 \text{ V}, \quad V = 2.5 \text{ V};$$

Based on these results, what range of power supply voltages are the most difficult to obtain in an efficient manner? Any suggestions for the improvement? \_

SOLUTION

BUCK-CONVERTER

R. TYMEKSKI

(I)

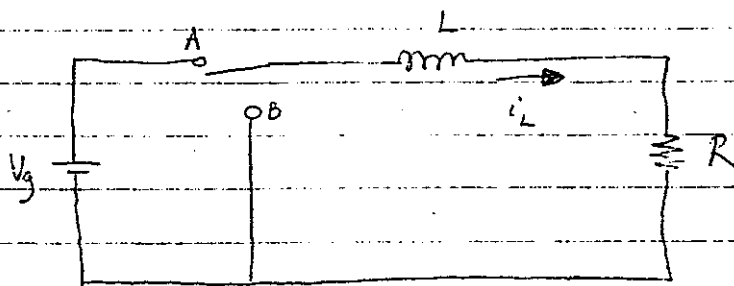

a/ With switch in position A

$$i_L(t) = \frac{V_g}{R} (1 - e^{-R/L t}) + I_1 e^{-R/L t} \quad (1)$$

With switch in position B

$$i_L(t) = I_2 e^{-R/L t} \quad (2)$$

At steady state we have  $i_L(0) = i_L(T_s)$

$$\text{i.e. } i_L(DT_s) - i_L(0) = i_L(DT_s) - i_L(T_s)$$

$$\text{i.e. } \Delta i_L |_{DT_s} = \Delta i_L |_{D'T_s}$$

(3)

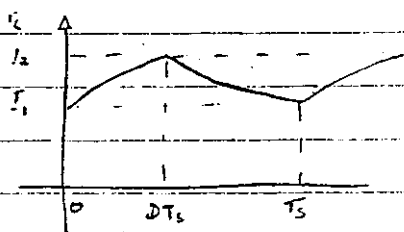

By (1) + (3)

$$\therefore I_2 = \frac{V_g}{R} (1 - e^{-R/L DT_s}) + I_1 e^{-R/L DT_s} \quad (4)$$

also by (2) + (3)

$$I_1 = I_2 e^{-R/L D'T_s} \quad (5)$$

(4) + (5)  $\Rightarrow$

$$I_2 = \frac{V_g}{R} (1 - e^{-R/L DT_s}) + I_2 e^{-R/L D'T_s}$$

$$\Rightarrow I_2 = \frac{V_g}{R} \left( \frac{1 - e^{-\frac{R}{L}DT_s}}{1 - e^{-\frac{R}{L}T_s}} \right) \quad (6)$$

By (5) we have

$$I_1 = \frac{V_g}{R} \left( \frac{1 - e^{-\frac{R}{L}DT_s}}{1 - e^{-\frac{R}{L}T_s}} \right) e^{-\frac{R}{L}DT_s} \quad (7)$$

b/ when  $\frac{R}{L} \ll f_s$  the exponentials may be approximated by the first two terms of the Taylor series.

$\therefore$  (6) becomes.

$$I_2 = \frac{V_g}{R} \left( \frac{1 - \left[ 1 - \frac{R}{L}DT_s \right]}{1 - \left[ 1 - \frac{R}{L}T_s \right]} \right)$$

$$\Rightarrow I_2 = \frac{V_g}{R} D \quad (8)$$

Also (7) becomes.

$$I_1 = \frac{V_g D}{R} \left( 1 - \frac{R}{L}DT_s \right) \quad (9)$$

$\therefore$  By (8) + (9)

$$\Delta I_2 \triangleq I_2 - I_1 = \frac{V_g D DT_s}{L} \quad \checkmark$$

With  $R/L \ll f_s$  waveform is essentially linear

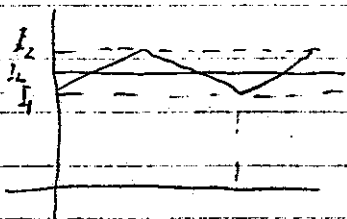

$$\text{Average inductor current} = I_1 + \frac{1}{2}(I_2 - I_1)$$

$$= \frac{V_g D}{R} \left( 1 - \frac{R}{L} D' T_s \right) + \frac{V_g D D' T_s}{2L}$$

$$= \frac{V_g D}{R} \left( 1 - \frac{R}{L} D' T_s + \frac{R D' T_s}{2L} \right)$$

$$I_L = \frac{V_g D}{R} \left( 1 - \frac{R}{L} \frac{D' T_s}{2} \right)$$

$$I \approx \frac{V_g D}{R} \quad \text{since } \frac{R}{L} \frac{D' T_s}{2} \ll 1$$

e/

$$\Delta V = \Delta I_L R$$

$$\Delta V = \frac{V_g D D' T_s R}{L}$$

$$V = I_L R$$

$$V = V_g D \left( 1 - \frac{R}{L} \frac{D' T_s}{2} \right) \approx V_g D \quad \text{since } \frac{R}{L} \frac{D' T_s}{2} \ll 1$$

$$\therefore \frac{\Delta V}{V} = \frac{V_g D D' T_s R}{L}$$

$$V_g D \left( 1 - \frac{R}{L} \frac{D' T_s}{2} \right)$$

$$= \frac{D' T_s R}{L \left( 1 - \frac{R}{L} \frac{D' T_s}{2} \right)} \approx \frac{D' T_s R}{L} \quad \text{since } \frac{R}{L} \frac{D' T_s}{2} \ll 1$$

$$\left( \therefore \frac{\Delta V}{V} = \frac{2}{\frac{2L}{RD'T_S} - 1} = \frac{2D'T_S}{L} \right)$$

(II.)

Since the capacitance voltage is the integral of its current,  $v = \int i dt$ , and since the capacitor ripple current is triangular in shape, the voltage ripple typically consists of segments of two parabolas. The total voltage ripple  $\Delta v$  is easily obtained from the stored charge  $\Delta Q$ , which corresponds to the area under inductor ripple.

Hence

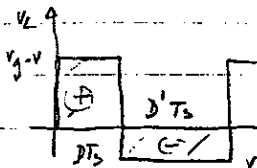

$$\Delta Q = \frac{1}{2} \left( \frac{DT_S}{2} + \frac{D'T_S}{2} \right) \frac{\Delta i_L}{2}$$

$$= \frac{1}{8} T_S \Delta i_L$$

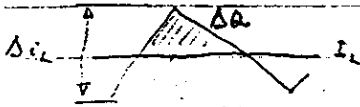

From the falling slope of the inductor current  $v/L$

$$\Delta i_L = \frac{V}{L} D'T_S$$

Thus the absolute voltage ripple

$$\Delta V = \frac{\Delta Q}{C} = \frac{1}{8} \frac{T_S \Delta i_L}{C} = \frac{1}{8} \frac{D'T_S^2}{LC} V$$

and

$$\frac{\Delta V}{V} = \frac{1}{8} \frac{D'T_S^2}{LC}$$

ALTERNATIVE METHOD TO FIND RIPPLE VOLTAGE

With the assumption that all the ripple current flows through the output capacitor and that no dc current flows through this capacitor, then the capacitor current looks like the following.

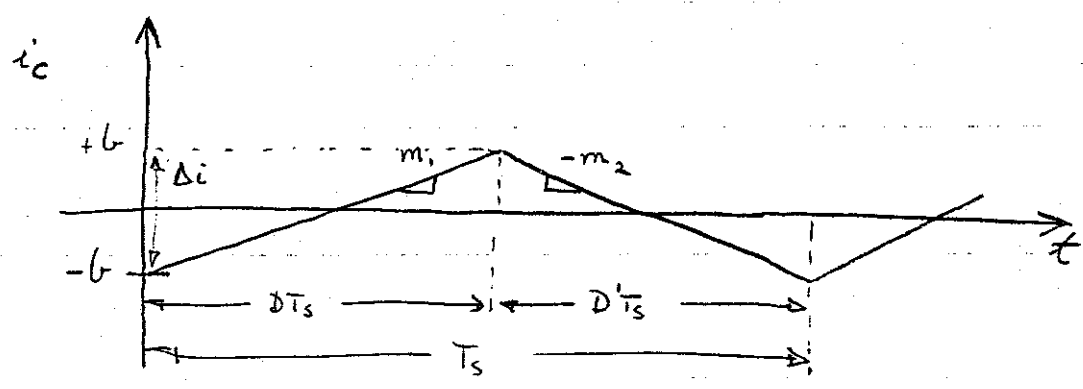

FIG. 1

The ripple voltage due to this ripple current can be evaluated from the basic capacitor equation:

$$i = c \frac{dv}{dt}$$

$$\Rightarrow \frac{1}{c} \int_0^t i(t) dt = v(t) \quad (1)$$

The current equations are given from inspection of Fig. 1 as follows:

(2)

$$i(t) = \begin{cases} m_1 t - b & , \quad 0 \leq t \leq DT_s & (2a) \\ -m_2 (t - DT_s) + b & , \quad DT_s \leq t \leq T_s & (2b) \end{cases}$$

Eqns. (2) describes one cycle of capacitor current. To find one cycle of capacitor voltage we use (1) together with (2):

$$v(t) = \begin{cases} \frac{1}{C} \int_0^t (m_1 t - b) dt & , \quad 0 \leq t \leq DT_s \\ \frac{1}{C} \int_{DT_s}^t [-m_2 (t - DT_s) + b] dt & , \quad DT_s \leq t \leq T_s \end{cases}$$

$$\Rightarrow v(t) = \begin{cases} \frac{1}{C} \left( \frac{m_1}{2} t^2 - b t \right) & , \quad 0 \leq t \leq DT_s & (3a) \\ \frac{1}{C} \left[ -\frac{m_2}{2} t^2 + (m_2 DT_s + b) t + \frac{m_2}{2} DT_s^2 - (m_2 DT_s + b) DT_s \right] & , \quad DT_s \leq t \leq T_s & (3b) \end{cases}$$

Eqn. 3 describes one cycle of capacitor voltage ripple.



3

We can differentiate (3a) and (3b) to determine where the maximum and minimum values of ripple occurs.

$$\frac{d\Delta(t)}{dt} = 0 \Rightarrow \begin{cases} m_1 t - b = 0 \Rightarrow t = \frac{b}{m_1}, & (4a) \\ & 0 \leq t \leq DT_s \\ -m_2 t + m_2 DT_s + b = 0 \Rightarrow t = \frac{m_2 DT_s + b}{m_2}, & (4b) \\ & DT_s \leq t \leq T_s \end{cases}$$

Now for the buck converter:

$$m_1 = \frac{V_g - V}{L} = \frac{D'V_g}{L}$$

$$m_2 = \frac{V}{L} = \frac{DV_g}{L}$$

$$b = \frac{\Delta i}{2} = \frac{DV_g}{L} \frac{D'T_s}{2}$$

By finding second derivatives we can see that the minimum in the voltage ripple occurs at  $t = \frac{b}{m_1} = \frac{\frac{DV_g}{L} \frac{D'T_s}{2}}{\frac{D'V_g}{L}} = \frac{DT_s}{2}$

(4)

which is within the interval of validity ( $0 \leq t \leq DT_s$ ) of the first subinterval. In fact the minimum in the output voltage occurs half-way through the first subinterval.

Similarly, the maximum in the output voltage ripple occurs at

$$t = \frac{m_2 DT_s + b}{m_2} = DT_s + \frac{b}{m_2} = DT_s + \frac{\frac{D'V_g T_s}{2f}}{\frac{DV_g}{2f}}$$

$$= DT_s + \frac{D'T_s}{2}$$

which is at the center of the second subinterval and (hence) within its appropriate region of validity.

Now

$$|\Delta v| = |v_{\min} - v_{\max}|$$

$$= \frac{1}{C} \left[ \frac{m_1}{2} \left( \frac{DT_s}{2} \right)^2 - b \frac{DT_s}{2} \right]$$

$$- \frac{1}{C} \left[ -\frac{m_2}{2} \left( DT_s + \frac{D'T_s}{2} \right)^2 + (m_2 DT_s + b) \left( DT_s + \frac{D'T_s}{2} \right) \right]$$

$$+ \frac{m_2}{2} D^2 T_s^2 - (m_2 DT_s + b) DT_s ]$$

(5)

$$= \frac{1}{C} \left[ \frac{D'V_g}{2L} \frac{D^2T_s^2}{4} - \frac{DD'V_gT_s}{2L} \frac{DT_s}{2} \right]$$

$$- \frac{1}{C} \left[ - \frac{DV_g}{2L} \left( DT_s + \frac{D'T_s}{2} \right)^2 + \left( \frac{DV_g}{L} DT_s + \frac{DD'V_gT_s}{2L} \right) \left( DT_s + \frac{D'T_s}{2} \right) \right. \\ \left. + \frac{DV_g}{2L} D^2T_s^2 - \left( \frac{DV_g}{L} DT_s + \frac{DD'V_gT_s}{2L} \right) DT_s \right]$$

$$= \frac{1}{C} \left[ \frac{D'D^2V_gT_s^2}{8L} - \frac{D'D^2V_gT_s^2}{4L} + \frac{DV_g}{2L} \left( D^2T_s^2 + \frac{D'^2T_s^2}{4} + DD'T_s^2 \right) \right.$$

$$- \frac{D^3V_gT_s^2}{L} - \frac{D^2D'V_gT_s^2}{2L} - \frac{D^2D'V_gT_s^2}{2L} - \frac{DD'^2V_gT_s^2}{4L}$$

$$\left. - \frac{D^3V_gT_s^2}{2L} + \frac{D^3V_gT_s^2}{L} + \frac{D^2D'V_gT_s^2}{2L} \right]$$

$$= \frac{1}{C} \frac{D'DV_gT_s^2}{L} \left[ \frac{D}{8} - \frac{D}{4} + \frac{D^2}{2D'} + \frac{D'}{8} + \frac{D}{2} - \frac{D^2}{D'} - \frac{D}{2} - \frac{D}{2} - \frac{D'}{4} \right.$$

$$\left. - \frac{D^2}{2D'} + \frac{D^2}{D'} + \frac{D}{2} \right]$$

$$= \frac{1}{C} \frac{D'DV_gT_s^2}{L} \left[ \frac{1}{8} - \frac{1}{4} \right]$$

=

$$\boxed{\frac{D'DV_gT_s^2}{8LC} = \Delta U}$$

(III)

a)  $C=0$ .

$$\frac{\Delta V}{V} = \frac{D'T_S R}{L} = \frac{(1 - \frac{V}{V_g}) T_S R}{L}$$

$$\Rightarrow L = \frac{\left(1 - \frac{7.5}{15}\right) (50 \times 10^{-6}) 100}{0.0025}$$

$\approx 1 \text{ H}$  ✓

$$\frac{L}{R} = 0.01 ; T_S = 50 \times 10^{-6} \Rightarrow \frac{L}{R} \gg T_S$$

$\Rightarrow$  approximate formula is well justified

b)  $C = 10 \mu\text{F}$

$$\frac{\Delta V}{V} = \frac{1}{8} \frac{D'T_S^2}{LC}$$

$$\Rightarrow L = \frac{\frac{1}{8} \left(1 - \frac{7.5}{15}\right) (50 \times 10^{-6})^2}{(10 \times 10^{-6}) (0.0025)}$$

$= 6.25 \text{ mH}$  ✓

$$\frac{L}{R} = 6.25 \times 10^{-2} ; T_S = 50 \times 10^{-6} \Rightarrow \frac{L}{R} \gg T_S$$

$\Rightarrow$  approximate formula is well justified.

(IV)

a/

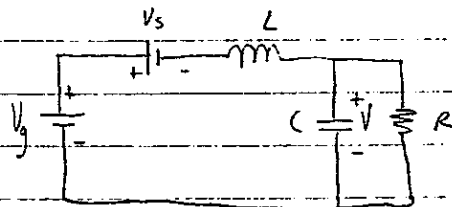

During  $DT_S$

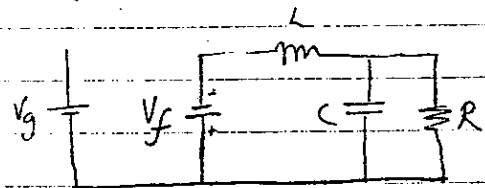

During  $D'T_S$

$$\text{Volt-sec balance} \Rightarrow (V_g - V_s - V) DT_S = (V + V_f) D'T_S$$

$$\Rightarrow \frac{V_o}{V_g} = \left( \frac{V_g - V_s + V_f}{V_g} \right) D - \frac{V_f}{V_g}$$

$$\text{or } \frac{V_o}{V_g} = D - \left( \frac{D V_s + D' V_f}{V_g} \right) \checkmark$$

$$b) \eta = \text{efficiency} = \frac{\text{output power}}{\text{input power}}$$

$$= \frac{V_o I_L}{V_g D I_L} \quad I_L - \text{average inductor current}$$

$$= \frac{V/V_s}{D} = \frac{\text{real voltage gain}}{\text{ideal voltage gain}}$$

$$\eta = \frac{V}{D V_g} \quad (A)$$

ALSO

$$\eta = \text{efficiency} = \frac{\text{output power}}{\text{output power} + \text{power loss}}$$

$$\text{output power} = I_L^2 R$$

$$\text{power loss} = \text{power loss in transistor} + \text{power loss in diode}$$

$$= I_L V_s D + I_L V_f D'$$

$$I_L^2 R$$

$$\eta = \frac{I_L^2 R}{I_L^2 R + I_L V_s D + I_L V_f D'}$$

Now  $I_L = \frac{V}{R}$

$$\Rightarrow \eta = \frac{V}{V + V_s D + V_f D'} \quad (B)$$

(A) + (B)  $\Rightarrow$

$$\eta = \frac{V}{V + V_s \frac{V}{\eta V_g} + V_f \left( \frac{1-V}{\eta V_g} \right)}$$

$$\Rightarrow \eta = \frac{V_g - V_s + V_f}{V_g} \cdot \frac{V}{V + V_f}$$

c/  $V_s = 0.5, V_f = 1.0$

i)  $V_g = 15 \text{ V}$   
 $V = 7.5 \text{ V}$

$$\eta = \frac{15 - 0.5 + 1}{15} \cdot \frac{7.5}{7.5 + 1}$$

$$\eta = 0.91$$

ii)  $V_g = 90 \text{ V}$   
 $V = 15 \text{ V}$

$$\eta = \frac{90 - 0.5 + 1}{90} \cdot \frac{15}{15 + 1}$$

$$\eta = 0.99$$

iii)  $V_g = 15$   
 $V = 2.5$

$$\eta = \frac{15 - 0.5 + 1}{15} \cdot \frac{2.5}{2.5 + 1}$$

$$\eta = 0.79$$

High efficiency is most difficult to obtain when in the range when the output voltage is small. ✓

In general, high efficiency is difficult to obtain when either input or output voltages are low and comparable to transistor and diode drops. Simultaneous low input and low output voltage conversion is even more inefficient.

To improve efficiency one might use a diode with a lower voltage drop, such as a Schottky diode. ✓

A transistor with lower saturation voltage would also increase efficiency. ✓

# HW # 1 APPENDIX:

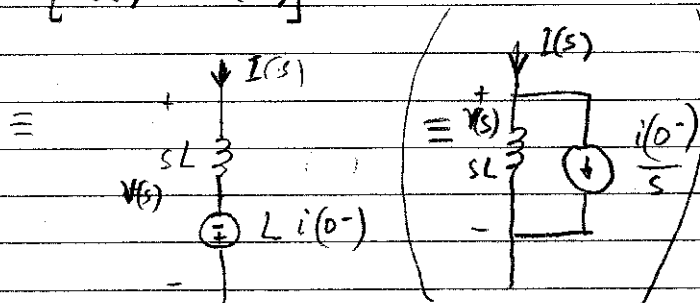
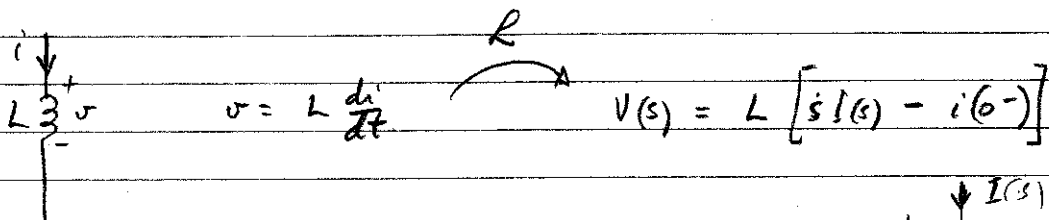
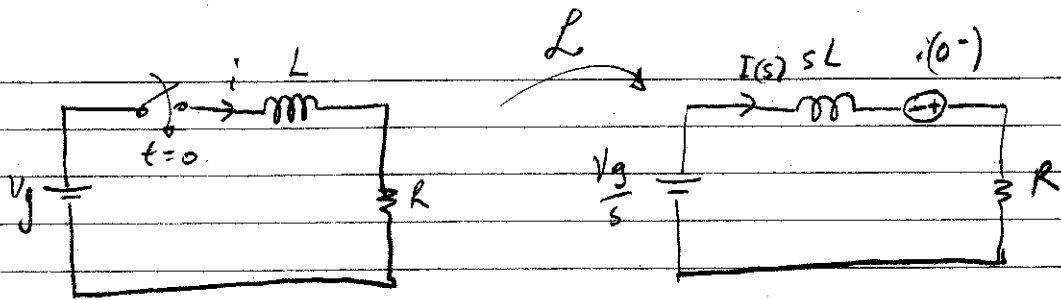

KVL  $\Rightarrow$

$$\frac{V_g}{s} = sL I(s) - Li(0^-) + I(s)R$$

$$\Rightarrow \frac{V_g}{s} = (sL + R) I(s) - Li(0^-)$$

$$\Rightarrow I(s) = \frac{V_g}{s} \frac{1}{sL + R} + \frac{Li(0^-)}{sL + R}$$

Now  $\frac{V_g}{s} \frac{1}{sL + R} = V_g \left[ \frac{a}{s} + \frac{b}{sL + R} \right]$

$$= V_g \left[ \frac{a(sL + R) + bs}{s(sL + R)} \right]$$

$$= V_g \left[ \frac{s(aL + b) + aR}{s(sL + R)} \right]$$

$$\Rightarrow a = \frac{1}{R}, \quad b = -\frac{L}{R}$$

$$= V_g \left( \frac{1}{R} \frac{1}{s} - \frac{L}{R} \frac{1}{sL + R} \right)$$

$$= \frac{V_g}{R} \left[ \frac{1}{s} - \frac{1}{s + \frac{R}{L}} \right]$$

Now  $\mathcal{L}^{-1} \left[ \frac{1}{s} \right] = u(t)$

$$\mathcal{L}^{-1} \left[ \frac{1}{s + a} \right] = e^{-at} u(t)$$

$\Rightarrow$

$$i(t) = \frac{V_g}{R} \left( 1 - e^{-\frac{R}{L}t} \right) u(t) - i(0^-) e^{-\frac{R}{L}t} u(t)$$



[2] N. MOHAN, T. UNDELAND, and W. ROBBINS, *Power Electronics: Converters, Applications, and Design*, 2nd edit., New York: John Wiley & Sons, 1995.  
 [3] J. KASSAKIAN, M. SCHLECHT, and G. VERGESE, *Principles of Power Electronics*, Reading, MA: Addison-Wesley, 1991.  
 [4] R. SEVERNS and G. E. BLOOM, *Modern Dc-to-Dc Switch Mode Power Converter Circuits*, New York: Van Nostrand Reinhold, 1985.  
 [5] K. KIT SUM, *Switch Mode Power Conversion—Basic Theory and Design*, New York: Marcel Dekker, 1984.

**PROBLEMS**

2.1 Analysis and design of a buck-boost converter: A buck-boost converter is illustrated in Fig. 2.28(a), and a practical implementation using a transistor and diode is shown in Fig. 2.28(b).

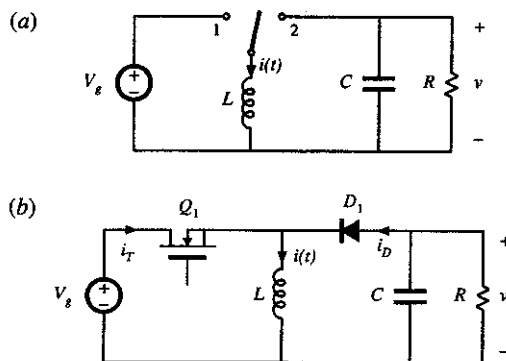

Fig. 2.28

- (a) Find the dependence of the equilibrium output voltage  $V$  and inductor current  $I$  on the duty ratio  $D$ , input voltage  $V_g$ , and load resistance  $R$ . You may assume that the inductor current ripple and capacitor voltage ripple are small.
- (b) Plot your results of part (a) over the range  $0 \leq D \leq 1$ .
- (c) Dc design: for the specifications

$$\begin{aligned} V_g &= 30 \text{ V} & V &= -20 \text{ V} \\ R &= 4 \Omega & f_s &= 40 \text{ kHz} \end{aligned}$$

- (i) Find  $D$  and  $I$
- (ii) Calculate the value of  $L$  that will make the peak inductor current ripple  $\Delta i$  equal to ten percent of the average inductor current  $I$ .
- (iii) Choose  $C$  such that the peak output voltage ripple  $\Delta v$  is 0.1 V.
- (d) Sketch the transistor drain current waveform  $i_T(t)$  for your design of part (c). Include the effects of inductor current ripple. What is the peak value of  $i_T$ ? Also sketch  $i_T(t)$  for the case when  $L$  is decreased such that  $\Delta i$  is 50% of  $I$ . What happens to the peak value of  $i_T$  in this case?
- (e) Sketch the diode current waveform  $i_D(t)$  for the two cases of part (d).

2.2

In a certain application, an unregulated dc input voltage can vary between 18 and 36 V. It is desired to produce a regulated output of 28 V to supply a 2 A load. Hence, a converter is needed that is capable of

$t \rightarrow$

$\Delta i$

$t \rightarrow$

continuous.

or the integral over one inverter to find its dc, or s.

a well-designed converter, compared to the respective

voltage components in any r must be zero.

omponents of the inductor a capacitor must be zero.

verforms, the ac switching then be chosen to obtain

s and currents are applied g ripple in these elements ents, without use of the

voltage polarity (buck-boost problems and in a later

and Control," in *Advances* l.

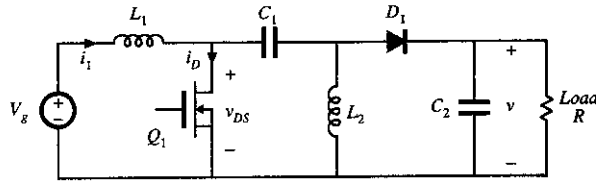

Fig. 2.29

both increasing and decreasing the voltage. Since the input and output voltages are both positive, converters that invert the voltage polarity (such as the basic buck-boost converter) are not suited for this application.

One converter that is capable of performing the required function is the nonisolated SEPIC (single-ended primary inductance converter) shown in Fig. 2.29. This converter has a conversion ratio  $M(D)$  that can both buck and boost the voltage, but the voltage polarity is not inverted. In the normal converter operating mode, the transistor conducts during the first subinterval ( $0 \leq t \leq DT_s$ ), and the diode conducts during the second subinterval ( $DT_s \leq t \leq T_s$ ). You may assume that all elements are ideal.

- (a) Derive expressions for the dc components of each capacitor voltage and inductor current, as functions of the duty cycle  $D$ , the input voltage  $V_g$ , and the load resistance  $R$ .
- (b) A control circuit automatically adjusts the converter duty cycle  $D$ , to maintain a constant output voltage of  $V = 28$  V. The input voltage slowly varies over the range  $18 \text{ V} \leq V_g \leq 36 \text{ V}$ . The load current is constant and equal to 2 A. Over what range will the duty cycle  $D$  vary? Over what range will the input inductor current dc component  $I_1$  vary?

2.3

- For the SEPIC of Problem 2.2,
  - (a) Derive expressions for each inductor current ripple and capacitor voltage ripple. Express these quantities as functions of the switching period  $T_s$ ; the component values  $L_1, L_2, C_1, C_2$ ; the duty cycle  $D$ ; the input voltage  $V_g$ ; and the load resistance  $R$ .
  - (b) Sketch the waveforms of the transistor voltage  $v_{DS}(t)$  and transistor current  $i_D(t)$ , and give expressions for their peak values.

- 2.4 The switches in the converter of Fig. 2.30 operate synchronously: each is in position 1 for  $0 \leq t \leq DT_s$ , and in position 2 for  $DT_s \leq t \leq T_s$ . Derive an expression for the voltage conversion ratio  $M(D) = V/V_g$ . Sketch  $M(D)$  vs.  $D$ .

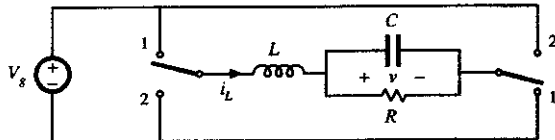

Fig. 2.30

- 2.5 The switches in the converter of Fig. 2.31 operate synchronously: each is in position 1 for  $0 \leq t \leq DT_s$ , and in position 2 for  $DT_s \leq t \leq T_s$ . Derive an expression for the voltage conversion ratio  $M(D) = V/V_g$ . Sketch  $M(D)$  vs.  $D$ .

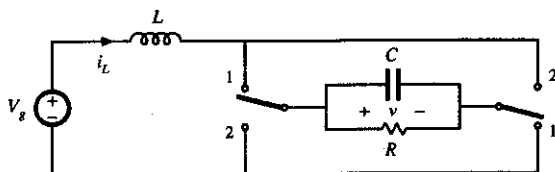

Fig. 2.31

- 2.6 For the converter of ripple  $\Delta v_C$ .
- 2.7 For the converter of  $I$ , as a function of  $I$
- 2.8 For the converter of ripple  $\Delta v_C$ .
- 2.9 To reduce the switch consisting of induct to meet regulations assume that all indu small.

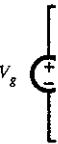
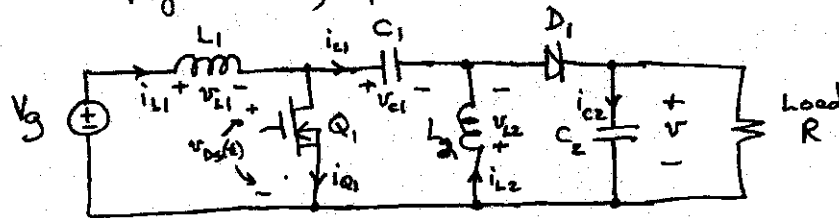

Fig. 2.32

- (a) Sketch the tra
  - (b) Derive analytic
  - (c) Derive analytic capacitor volta
  - (d) Given the foll
- Input voltage  
Output voltage  
Switching freq  
Load resistance
- Select values f  
component  $V_{C1}$
- Extra credit probl**  
and (ii) the peak-to-  
Do not make the sr

Solution to Problem 2.2

A dc voltage regulator based on the SEPIC Converter analysis  
Fig. 2.29, p. 38



A  
caveat

Label voltage and current for each inductor and capacitor. Defined directions of current and voltage must be consistent:

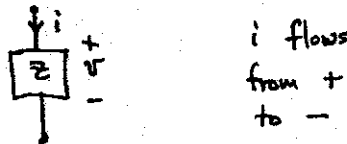

First subinterval:  $0 \leq t \leq DT_s$

transistor is on, diode is off  
circuit becomes

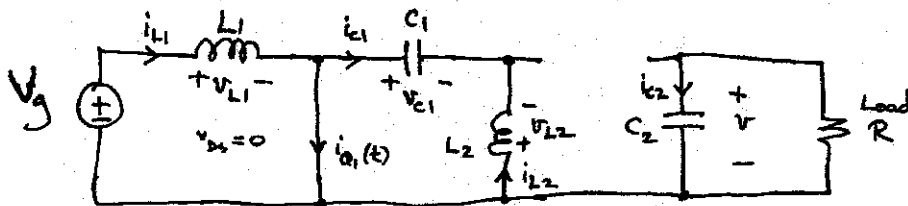

A  
caveat

Note: be careful to be consistent in your defined polarities of voltage and current. The same polarities must be followed during all subintervals!

Inductor voltages and capacitor currents for this subinterval:

$$v_{L1}(t) = V_g, \quad v_{L2}(t) = v_{C1}(t), \quad i_{C1}(t) = -i_{L2}(t), \\ i_{C2}(t) = -v(t)/R$$

Note that each inductor voltage and capacitor current has been expressed in terms of quantities that have small ripple when  $L_1, L_2, C_1,$  and  $C_2$  are sufficiently large. We can therefore make the small ripple approximation and write

$$i_{L1}(t) \approx I_{L1}$$

$$v_{C1}(t) \approx V_{C1}$$

$$i_{L2}(t) \approx I_{L2}$$

$$v(t) \approx V$$

So we obtain

$$v_{L1}(t) = V_g$$

$$v_{L2}(t) \approx V_{C1}$$

$$i_{C1}(t) \approx -I_{L2}$$

$$i_{C2}(t) \approx -V/R$$

A  
Caveat

We could have written the equations for subinterval 1 in other ways. For example, we could have expressed  $i_{C1}(t)$  as

$$i_{C1}(t) = i_{L1}(t) - i_{Q1}(t)$$

While this equation is true, it is not as useful because the switching ripple in the transistor current  $i_{Q1}(t)$  is not small:

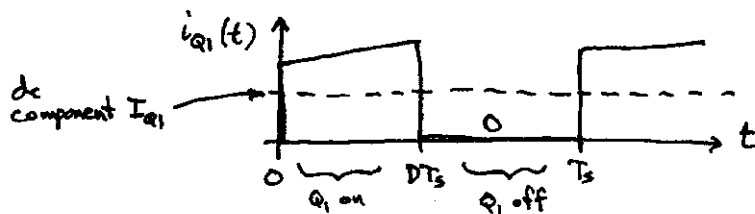

So we cannot write  
 $i_{Q1}(t) \approx I_{Q1}$  for  
 subinterval 1

Second subinterval:  $DT_s \leq t \leq T_s$

transistor is off, diode is on

Circuit becomes

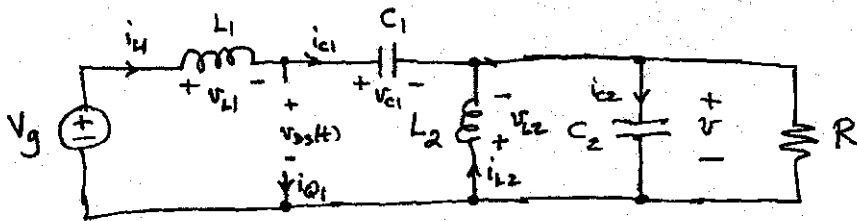

Inductor voltages and capacitor currents for this subinterval:

$$v_{L1}(t) = V_g - v_{C1}(t) - v(t)$$

$$v_{L2}(t) = -v(t)$$

$$i_{C1}(t) = i_{L1}(t)$$

$$i_{C2}(t) = i_{L1}(t) + i_{L2}(t) - v(t)/R$$

Again, note that  $v_{L1}$ ,  $v_{L2}$ ,  $i_{C1}$ , and  $i_{C2}$  are expressed in terms of quantities that have small ripple (i.e.,  $i_{L1}(t)$ ,  $i_{L2}(t)$ ,  $v_{C1}(t)$ ,  $v(t)$ , and  $V_g$ ) and not as functions of quantities whose ripples are not small (such as  $v_{L1}(t)$ ,  $v_{L2}(t)$ ,  $i_{C1}(t)$ ,  $i_{C2}(t)$ , and  $i_Q(t)$ ). Use of the small ripple approximation now leads to

$$v_{L1}(t) \approx V_g - V_{C1} - V$$

$$v_{L2}(t) \approx -V$$

$$i_{C1}(t) \approx I_{L1}$$

$$i_{C2}(t) \approx I_{L1} + I_{L2} - V/R$$

Waveforms:

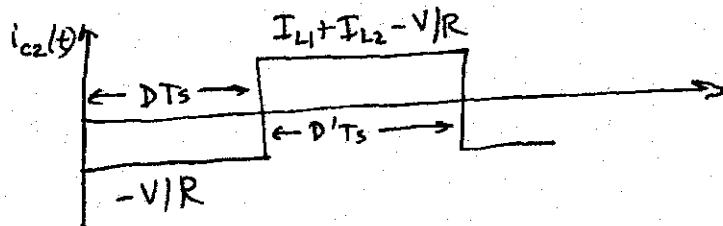
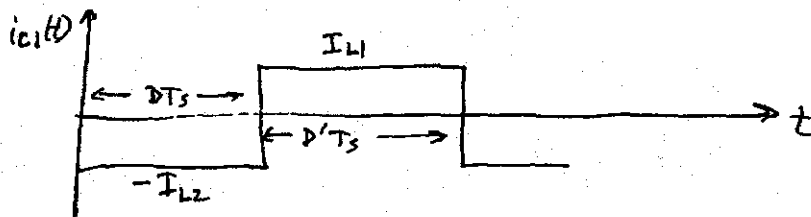
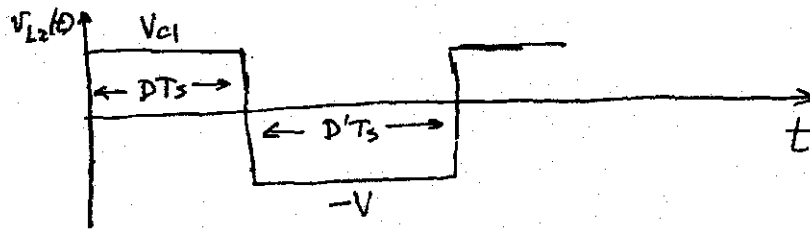
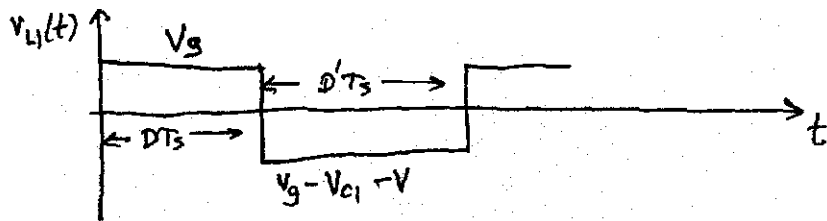

Volt-second balance

$$\langle v_{L1} \rangle_{T_s} = D(V_g) + D'(V_g - V_{c1} - V) = 0$$

$$\langle v_{L2} \rangle_{T_s} = D(V_{c1}) + D'(-V) = 0$$

with  $D' = 1 - D$

charge balance

$$\langle i_{c1} \rangle_{T_s} = D(-I_{L2}) + D'(I_{L1}) = 0$$

$$\langle i_{c2} \rangle_{T_s} = D\left(-\frac{V}{R}\right) + D'\left(I_{L1} + I_{L2} - \frac{V}{R}\right) = 0$$

④

Four equations and four unknowns ( $V, V_{c1}, I_{L1}, I_{L2}$ ).

Solution:

$$V_{c1} = V_g$$

$$V = \frac{D}{1-D} V_g$$

$$I_{L1} = \frac{D}{1-D} \frac{V}{R} = \left(\frac{D}{1-D}\right)^2 \frac{V_g}{R}$$

$$I_{L2} = \frac{V}{R} = \frac{D}{(1-D)} \frac{V_g}{R}$$

Part (b): voltage regulator behavior

Controller automatically adjusts  $D$ , to maintain  $V = 28$  volts.

Input voltage varies over the range  $18 \leq V_g \leq 36$ .

Load current = 2A =  $\frac{V}{R}$ , so  $R = \frac{(28 \text{ volts})}{(2 \text{ amps})} = 14 \Omega$ .

over what ranges do  $D$  and  $I_{L1}$  vary?

We know that  $V = \frac{D}{1-D} V_g$ . Solve for  $D$ :

$$V - DV = DV_g$$

$$V = D(V + V_g)$$

$$\Rightarrow D = \frac{V}{V + V_g}$$

and from above,

$$I_{L1} = \frac{D}{1-D} \frac{V}{R} = \frac{V^2}{V_g R}$$

$V$	$V_g$	$D$	$I_{L1}$
28	18	$\frac{28}{46} = 0.609$	$\frac{28^2}{(18)(14)} = 3.11 \text{ A}$
28	36	$\frac{28}{64} = 0.438$	$\frac{28^2}{(36)(14)} = 1.56 \text{ A}$

End of problem 2.2

Solution to Problem 2.3

See solution to problem 2.2 for subinterval circuits, equations, small ripple approximation, capacitor current and inductor voltage waveforms, and solution for dc voltages and currents.

- a) Derive expressions for inductor current ripples and capacitor voltage ripples

Inductor  $L_1$

Voltage waveform (from problem 2.2):

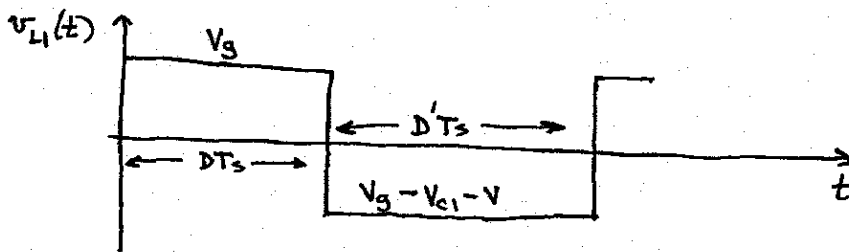

Slope of inductor current is found using  $L_1 \frac{di_L(t)}{dt} = v_{L1}(t)$

so  $\frac{di_L(t)}{dt} = \frac{v_{L1}(t)}{L_1}$ . [During a given subinterval, the voltage  $v_{L1}(t)$  is essentially constant  $\Rightarrow$  constant slope  $\frac{di_L(t)}{dt}$ .]

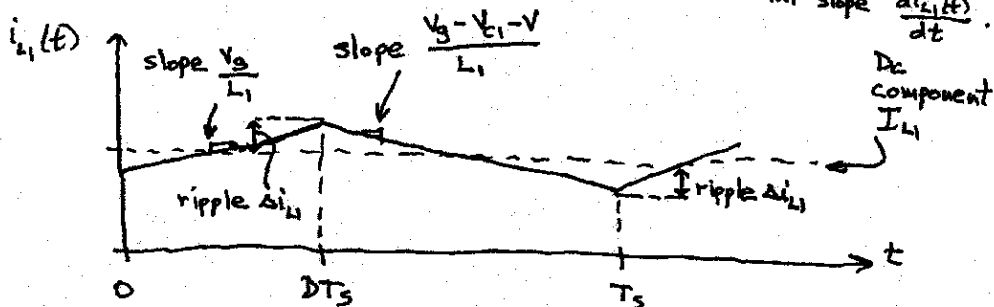



Peak ripple (i.e., peak-to-average) =  $\Delta i_{L1}$

peak-to-peak ripple =  $2 \Delta i_{L1}$

During first subinterval,  $i_{L1}(t)$  changes from  $(I_{L1} - \Delta i_{L1})$  to  $(I_{L1} + \Delta i_{L1})$ , for a total change of  $2 \Delta i_{L1}$ .

(change in  $i_{L1}(t)$ ) = (slope) (time)

$$(2 \Delta i_{L1}) = \left( \frac{V_g}{L_1} \right) (DT_s) \quad \text{for first subinterval}$$

so 
$$\Delta i_{L1} = \frac{V_g DT_s}{2 L_1}$$

The same result could be derived via a similar analysis of subinterval 2.

### Inductor $L_2$

Voltage waveform, from problem 2.2:

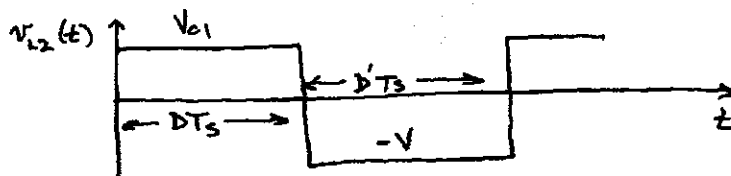

so we obtain

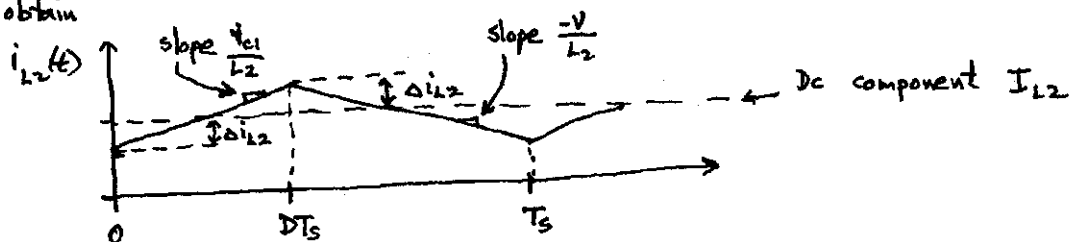

First subinterval :

$$\underbrace{2\Delta i_{L2}}_{\text{change in } i_{L2}(t)} = \underbrace{\left(\frac{V_{c1}}{L_2}\right)}_{\text{slope}} \underbrace{(DT_s)}_{\text{time}}$$

solve for  $\Delta i_{L2}$  :

$$\Delta i_{L2} = \frac{V_{c1} DT_s}{2L_2}$$

In problem 2.2, it was found that  $V_{c1} = V_g$ . So

$$\Delta i_{L2} = \frac{V_g DT_s}{2L_2}$$

Capacitor  $C_1$

Current waveform, from problem 2.2:

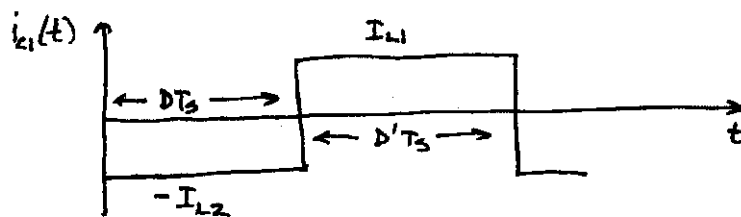

so the capacitor voltage waveform is found using the relationship  $i_{c1}(t) = C_1 \frac{dv_{c1}(t)}{dt}$

$$\text{slope } \frac{dv_{c1}(t)}{dt} = \frac{i_{c1}(t)}{C_1}$$

During a given subinterval, the current  $i_{c1}(t)$  is essentially constant  $\Rightarrow$  constant slope.

Slope during first subinterval  $0 < t < DT_s$  is  $-\frac{I_{L2}}{C_1}$

Slope during second subinterval  $DT_s < t < T_s$  is  $I_{L1}/C_1$

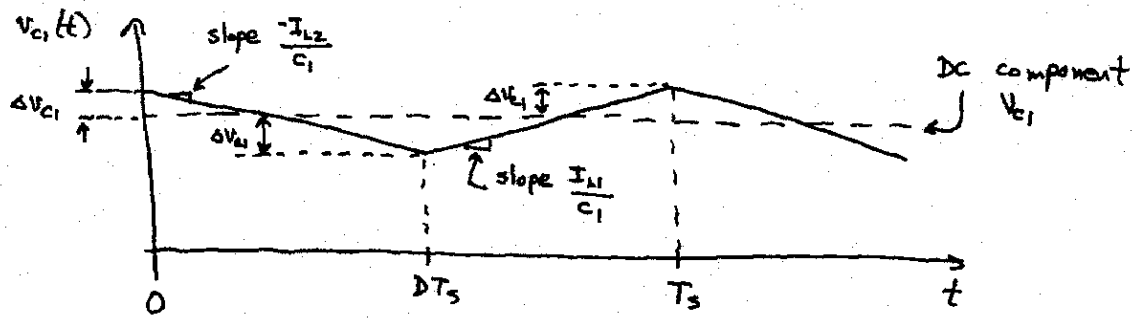

During the first subinterval,  $v_{c1}(t)$  changes by

$$\underbrace{(-2 \Delta v_{c1})}_{\substack{\text{change} \\ \text{during} \\ \text{during} \\ 0 < t < DT_s}} = \underbrace{\left(-\frac{I_{L2}}{C_1}\right)}_{\text{slope}} \underbrace{(DT_s)}_{\text{time}}$$

Solve for  $\Delta v_{c1}$ :

$$\Delta v_{c1} = \frac{I_{L2} DT_s}{2C_1}$$

Substitute solution for  $I_{L2}$  (from problem 2.2):  $I_{L2} = \frac{D}{(D')^2} \frac{V_g}{R}$

$$\Delta v_{c1} = \left(\frac{D}{D'}\right)^2 \frac{V_g T_s}{2RC_1}$$

## Capacitor $C_2$

Current waveform  $i_{c2}(t)$ , from problem 2.2:

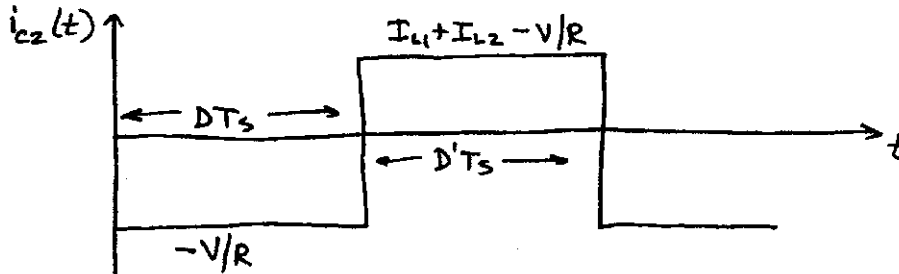

So the capacitor voltage waveform is

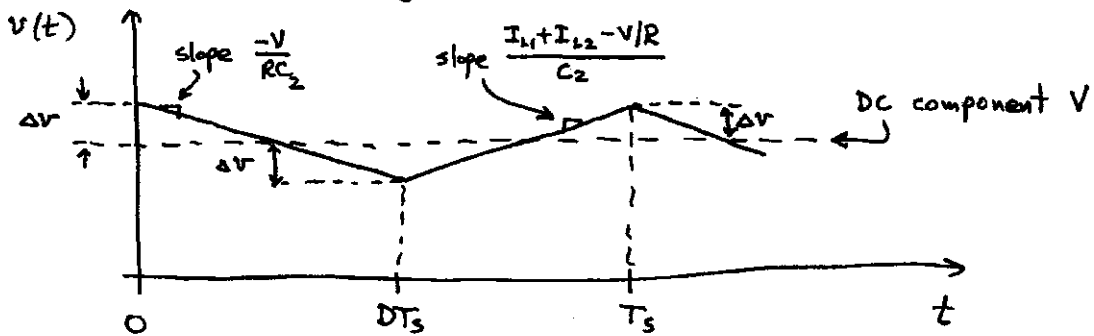

Change in capacitor voltage during first subinterval is

$$(-2\Delta v) = \left(-\frac{V}{RC_2}\right)(DT_s)$$

$$\Rightarrow \Delta v = \frac{VDT_s}{2RC_2}$$

Substitute solution for  $V$  from problem 2.2:  $V = \frac{D}{D'} V_g$

$$\Delta v = \frac{D^2}{D'} \frac{V_g T_s}{2RC_2}$$

b) Sketch the waveforms of the transistor voltage  $v_{DS}(t)$  and transistor current  $i_D(t)$ , and give expressions for their peak values.

Again, refer to schematic and waveforms in solution to problem 2.2. The transistor current  $i_D(t) = i_{Q1}(t)$  is sketched in the problem 2.2 solution.

The transistor drain-to-source voltage  $v_{DS}(t)$  is equal to approximately zero during the first subinterval, when the transistor conducts. During the second subinterval, the transistor is off and the diode conducts. The converter circuit is then as sketched on p.3 of the prob. 2.2 solution. It can be seen that

$$\textcircled{*} \quad v_{DS}(t) = v_{C1}(t) + v(t) \quad \text{for subinterval 2}$$

small ripple approximation

$$\begin{aligned} v_{DS}(t) &\approx V_{C1} + V \\ &= V_g + \frac{D}{D'} V_g \quad \text{using solution for } V_{C1} \text{ and } V \\ &= V_g \left( \frac{D'+D}{D'} \right) \quad \text{note } D'+D=1 \\ &= \frac{1}{D'} V_g \end{aligned}$$

[ A caveat: Eq.  $\textcircled{*}$  above is expressed in terms of quantities that have small ripple:  $v_{C1}(t)$  and  $v(t)$ . We could have instead written  $v_{DS}(t) = V_g - v_{L1}(t)$ , but the result would not be useful because the switching ripple in  $v_{L1}(t)$  is not small and cannot be ignored!

$\textcircled{6}$

So the transistor voltage waveform is

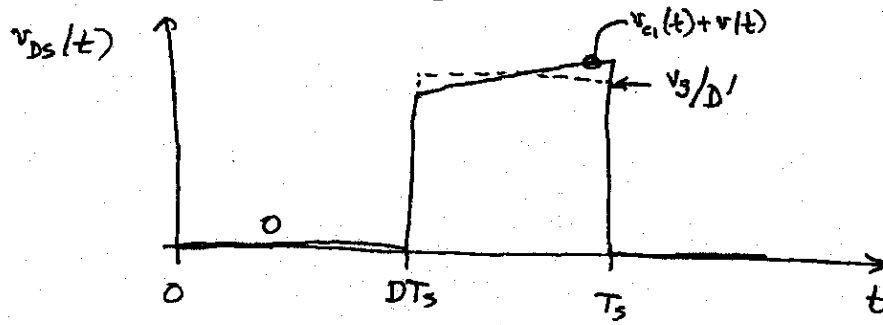

End of problem 2.3

EE445 / 545

STATE EQUATIONS

R. TYMERSKI

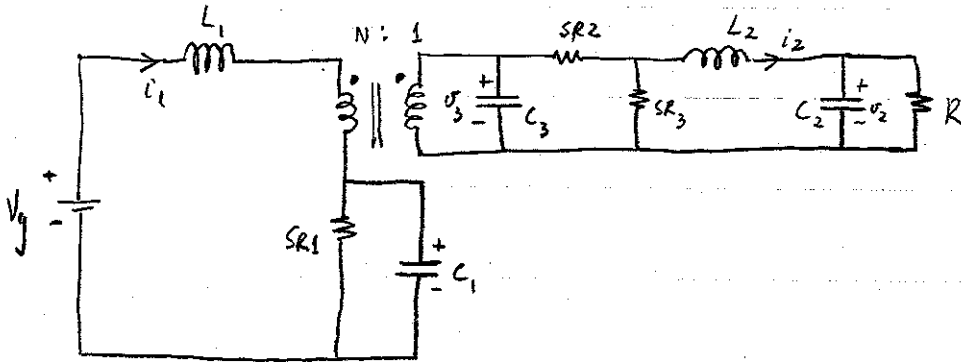

We wish to find the state equations for the above circuit. We will model the transformer as follows,

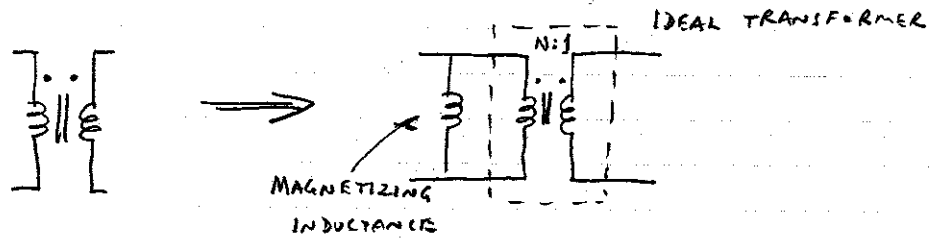

so that the above circuit appears as

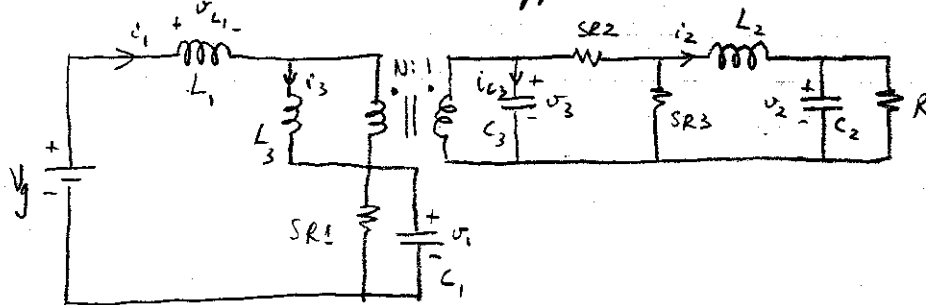

Find the state equations with  $x = [i_1 \ i_2 \ i_3 \ v_1 \ v_2 \ v_3]^T$ .

We consider the outputs to be  $v_{L1}$ , the voltage across  $L_1$ ;  $i_{C3}$ , the current through  $C_3$  and  $v_2$ , the voltage across  $C_2$ , therefore  $y = [v_{L1} \ i_{C3} \ v_2]^T$ .

Clearly show what your  $\{A, B, C, E\}$  matrices are.

SOLUTION  
EE445/EE545  
AND  
EE451/EE551

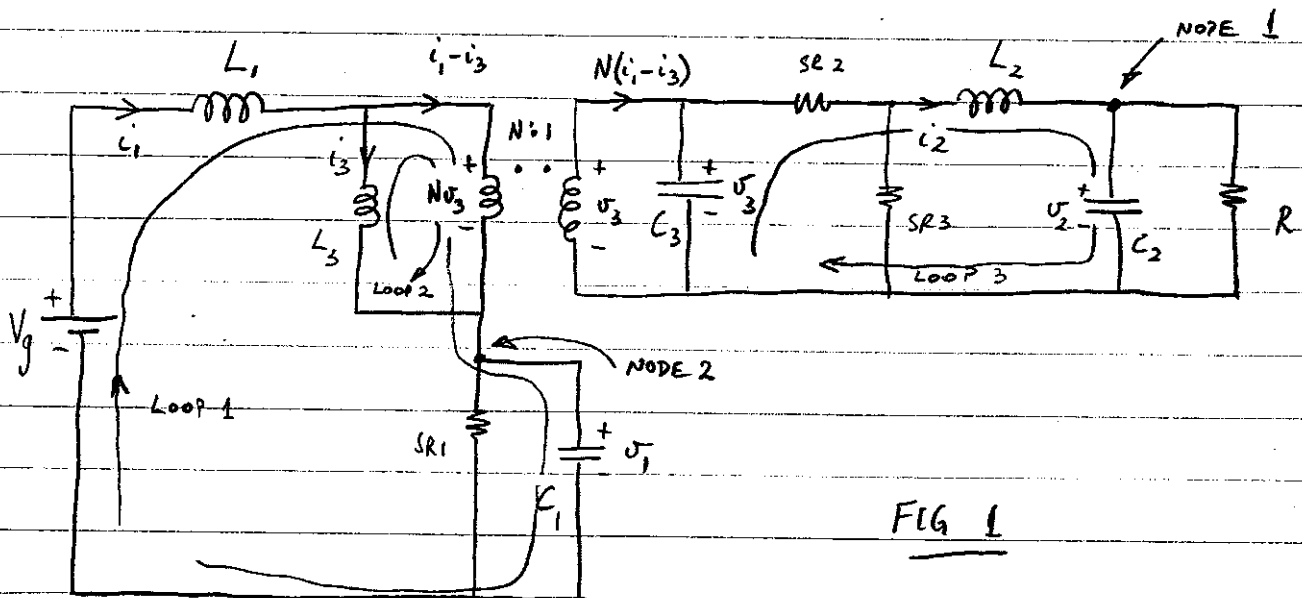

KVL Loop 1  $\Rightarrow$

$$-V_g + L_1 \frac{di_1}{dt} + N\sigma_3 + \sigma_1 = 0 \Rightarrow L_1 \frac{di_1}{dt} = -\sigma_1 - N\sigma_3 + V_g \quad (1)$$

KVL Loop 2  $\Rightarrow$

$$L_3 \frac{di_3}{dt} - N\sigma_3 = 0 \Rightarrow L_3 \frac{di_3}{dt} = N\sigma_3 \quad (2)$$

KCL NODE 1  $\Rightarrow$

$$i_2 = C_2 \frac{d\sigma_2}{dt} + \frac{\sigma_2}{R} \Rightarrow C_2 \frac{d\sigma_2}{dt} = i_2 - \frac{\sigma_2}{R} \quad (3)$$

KCL NODE 2  $\Rightarrow$

$$C_1 \frac{d\sigma_1}{dt} = i_1 - \frac{\sigma_1}{SR1} \quad (4)$$



(2)

KVL LOOP 3  $\Rightarrow$

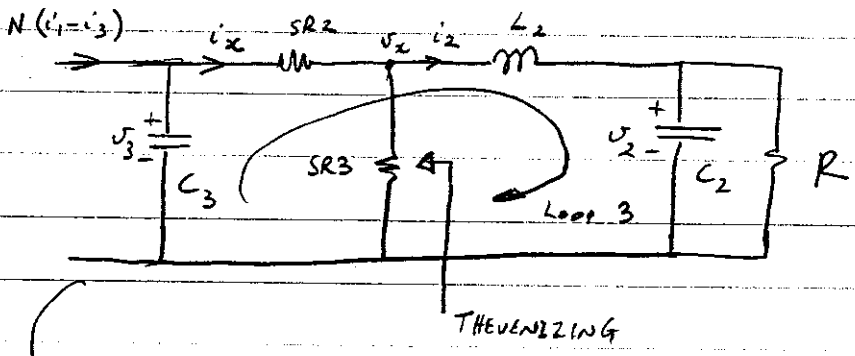

FIG. 2

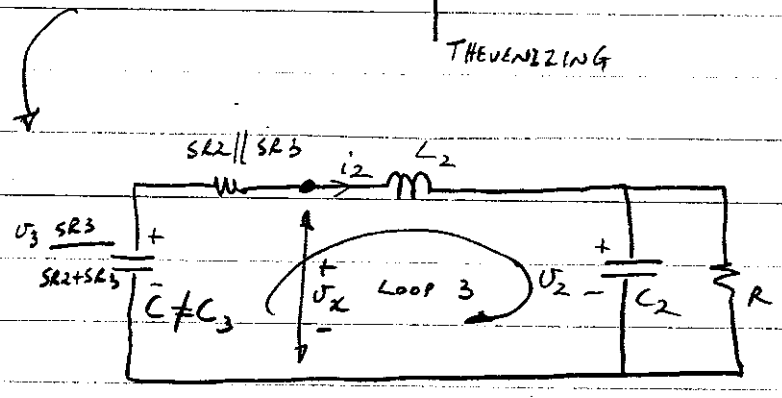

FIG 3

$$-v_3 \frac{SR_3}{SR_2 + SR_3} + i_2 (SR_2 \parallel SR_3) + L_2 \frac{di_2}{dt} + v_2 = 0$$

$$\Rightarrow L_2 \frac{di_2}{dt} = -i_2 (SR_2 \parallel SR_3) - v_2 + v_3 \frac{SR_3}{SR_2 + SR_3} \quad (5)$$

We have 5 state equations now, we need the state equation involving  $C_3 \frac{dv_3}{dt}$ . This is done as follows.

From Fig 3 we see that voltage  $v_x$  is

$$v_x = v_3 \frac{SR_3}{SR_2 + SR_3} - i_2 (SR_2 \parallel SR_3) \quad (A)$$

(3)

From Fig. 2 we see

$$i_x = N(i_1 - i_3) - c_3 \frac{d\sigma_3}{dt} \quad (B)$$

and also

$$\sigma_x = (i_x - i_2) SR_3 \quad (C)$$

$$B + (C) \Rightarrow$$

$$\sigma_x = \left[ N(i_1 - i_3) - c_3 \frac{d\sigma_3}{dt} - i_2 \right] SR_3 \quad (D)$$

$$(A) + (D) \Rightarrow$$

$$\frac{\sigma_3 SR_3}{SR_2 + SR_3} - i_2 (SR_2 // SR_3) = \left[ N(i_1 - i_3) - c_3 \frac{d\sigma_3}{dt} - i_2 \right] SR_3$$

$$\Rightarrow -\sigma_3 \frac{1}{SR_2 + SR_3} + i_2 \frac{SR_2}{SR_2 + SR_3} + N(i_1 - i_3) - i_2 = c_3 \frac{d\sigma_3}{dt}$$

$$\text{since } SR_2 // SR_3 = \frac{SR_2 \times SR_3}{SR_2 + SR_3}$$

$$\Rightarrow c_3 \frac{d\sigma_3}{dt} = Ni_1 - \frac{SR_3}{SR_2 + SR_3} i_2 - Ni_3 - \frac{\sigma_3}{SR_2 + SR_3} \quad (6)$$

(4)

Arranging eqns. (1) - (6) in matrix form we have

$$\frac{d}{dt} \begin{bmatrix} i_1 \\ i_2 \\ i_3 \\ v_1 \\ v_2 \\ v_3 \end{bmatrix} = \underbrace{\begin{bmatrix} 0 & 0 & 0 & -\frac{1}{L_1} & 0 & -\frac{N}{L_1} \\ 0 & -\frac{SR_2 \parallel SR_3}{L_2} & 0 & 0 & -\frac{1}{L_2} & \frac{1}{L_2} \frac{SR_3}{SR_2 + SR_3} \\ 0 & 0 & 0 & 0 & 0 & \frac{N}{L_3} \\ \frac{1}{C_1} & 0 & 0 & -\frac{1}{C_1 SR_1} & 0 & 0 \\ 0 & \frac{1}{C_2} & 0 & 0 & -\frac{1}{RC_2} & 0 \\ \frac{N}{C_3} & -\left(\frac{SR_3}{SR_2 + SR_3}\right) \frac{1}{C_3} & -\frac{N}{C_3} & 0 & 0 & -\frac{1}{C_3 (SR_2 + SR_3)} \end{bmatrix}}_A \begin{bmatrix} i_1 \\ i_2 \\ i_3 \\ v_1 \\ v_2 \\ v_3 \end{bmatrix} + \underbrace{\begin{bmatrix} \frac{1}{L_1} \\ 0 \\ 0 \\ 0 \\ 0 \\ 0 \end{bmatrix}}_B V_g$$

OUTPUT EQUATION

$$y = \begin{bmatrix} v_{L1} \\ i_{L3} \\ v_2 \end{bmatrix}$$

Using eqn (1) with  $v_{L1} = L_1 \frac{di_1}{dt}$  we have

$$v_{L1} = -v_1 - Nv_3 + V_g \quad (7)$$

Using eqn (6) with  $i_{L3} = C_3 \frac{dv_3}{dt}$  we have

$$i_{L3} = N i_1 - \frac{SR3}{SR2 + SR3} i_2 - N i_3 - \frac{v_3}{SR2 + SR3} \quad (8)$$

Therefore the output eqn. is given by

$$y = \underbrace{\begin{bmatrix} 0 & 0 & 0 & -1 & 0 & -N \\ N i_1 & -\frac{SR3}{SR2 + SR3} i_2 & -N & 0 & 0 & -\frac{1}{SR2 + SR3} \\ 0 & 0 & 0 & 0 & 1 & 0 \end{bmatrix}}_C \begin{bmatrix} i_1 \\ i_2 \\ i_3 \\ v_1 \\ v_2 \\ v_3 \end{bmatrix} + \underbrace{\begin{bmatrix} 1 \\ 0 \\ 0 \end{bmatrix}}_E V_g$$

EE445/545

Power Electronics

BUCK-BOOST CONVERTER

I. BUCK-BOOST CONVERTER

1. A small 1.5 volt solar array is to be used to power a 5 volt, 1 ampere load. It has been decided to use a buck-boost converter in this application. A suitable transistor is found with an on-resistance of  $35 \text{ m}\Omega$ , and a Schottky diode is found with a forward voltage drop of 0.5 volts.

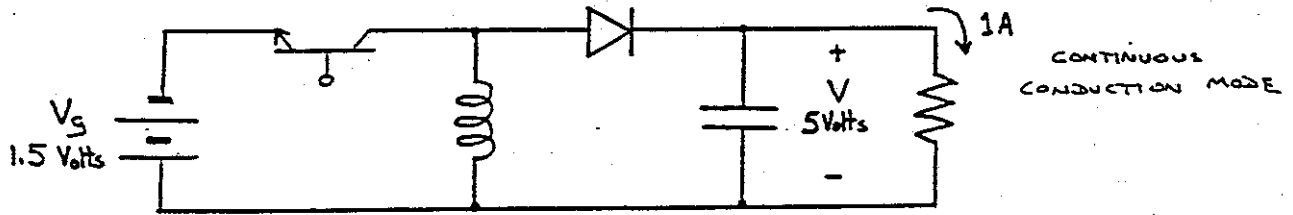

- a) Derive an equivalent circuit which models the dc properties of this converter. Include transistor and diode conduction losses, as well as inductor copper loss, but neglect all other sources of converter inefficiency.
- b) How large can the inductor winding resistance be and still allow this converter to operate at 70% efficiency? At what duty ratio will the converter then operate?
- c) Plot the converter output voltage and efficiency over the range  $0 \leq D \leq 1$  for the value of inductor winding resistance selected in part b).

# SOLUTIONS

## BUCK-BOOST CONVERTER

R. TYMERSKI

### I. BUCK-BOOST CONVERTER

a)

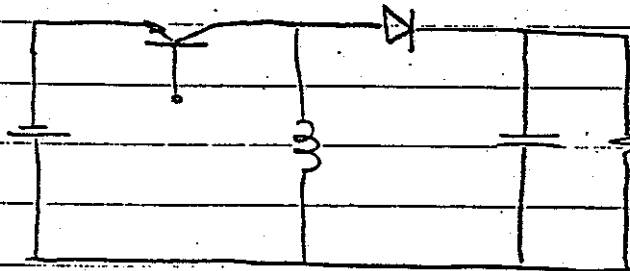
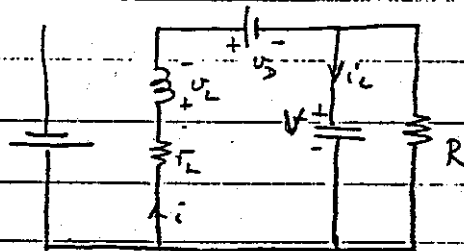
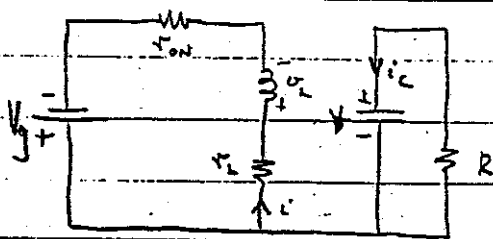

Fig 1

DURING DT<sub>s</sub>

DURING D'T<sub>s</sub>



$$v_L = V_g - i r_{on} - i r_L$$

$$v_L = -V - v_D - i r_L$$

$$i_c = -\frac{V}{R}$$

$$i_c = i - \frac{V}{R}$$

inductor volt-sec balance

$$\langle v_L \rangle = D (V_g - i r_{on} - i r_L) - D' (V + v_D + i r_L) = 0$$

$$\Rightarrow D V_g - i r_L - i D r_{on} - D' v_D - D' V = 0 \quad (1)$$

charge balance

$$\langle i_c \rangle = -D \frac{V}{R} + D' \left( i - \frac{V}{R} \right) = 0 \Rightarrow D' i - \frac{V}{R} = 0 \quad (2)$$

Circuit satisfying loop equation (1):

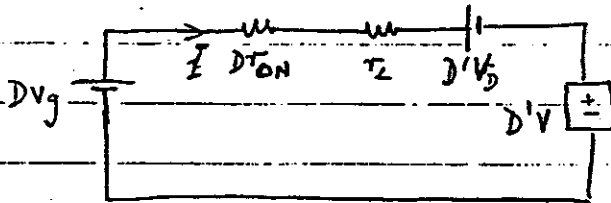

Circuit satisfying node equation (2):

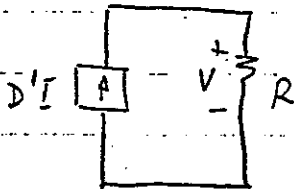

Combining:

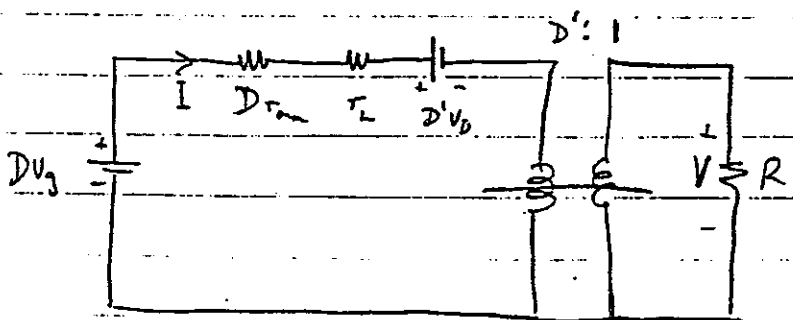
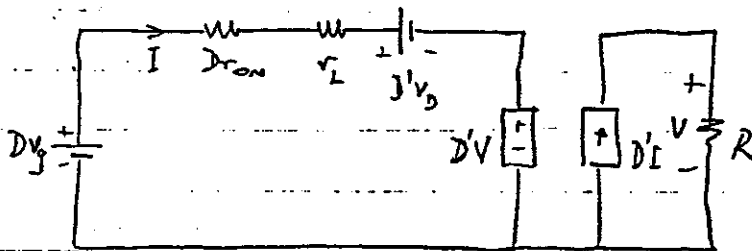

Can now reflect primary side into secondary

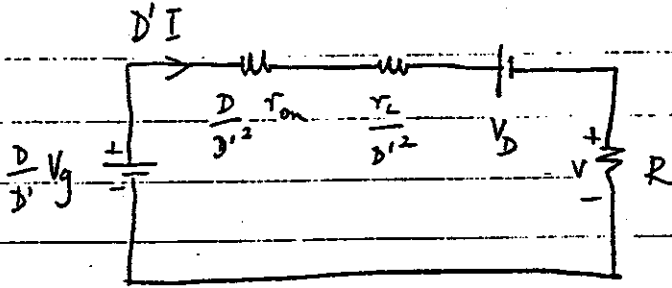

Fig. 2

$$b) \quad \eta = \text{efficiency} = \frac{P_{out}}{P_{in}} = \frac{(D'I)V}{\left(\frac{D}{D'} V_g\right) D'I} = \frac{D'}{D} \frac{V}{V_g}$$

$$\eta = \frac{D'}{D} \frac{V}{V_g} \Rightarrow D \eta V_g = V - DV$$

$$\Rightarrow D (V + \eta V_g) = V$$

$$\Rightarrow D = \frac{V}{V + \eta V_g}$$

$$\eta = 0.7 ; V_g = 1.5 ; V = 5$$

$$\Rightarrow D = \frac{5}{5 + 0.7(1.5)}$$

$$\Rightarrow D = 0.8264$$



To find  $r_L$  we write loop equation of Fig. 2

$$-\frac{D}{D'} V_g + D'I \left[ \frac{D}{D'^2} r_{on} + \frac{r_L}{D'^2} \right] + V_D + V = 0.$$

Multiply the above equation by  $D'^2 \Rightarrow$

$$-DD'V_g + DD'I r_{on} + D'I r_L + D'^2(V + V_D) = 0$$

$$\Rightarrow D'I r_L = DD'V_g - DD'I r_{on} - D'^2(V + V_D)$$

Now the output current (i.e. load current) is  
from fig 2  $= D'I = 1$

$$\therefore r_L = (0.8264)(1-0.8264)(1.5) - (0.8264)(1)(0.035) - (1-0.8264)^2(5+0.5)$$

$$\underline{r_L = 20.5 \text{ m}\Omega}$$

c) From Fig. 2 using voltage divider rule

$$V = \frac{R}{R + \frac{D}{D'^2} r_{on} + \frac{r_L}{D'^2}} \left( \frac{D}{D'} V_g - V_D \right) \quad (*)$$

also from before

$$\eta = \frac{D'}{D} \frac{V}{V_g} \quad (**)$$

where  $V$  is obtained from  $(*)$

(can use  $(*)$  and  $(**)$  to get plots.

Output Voltage

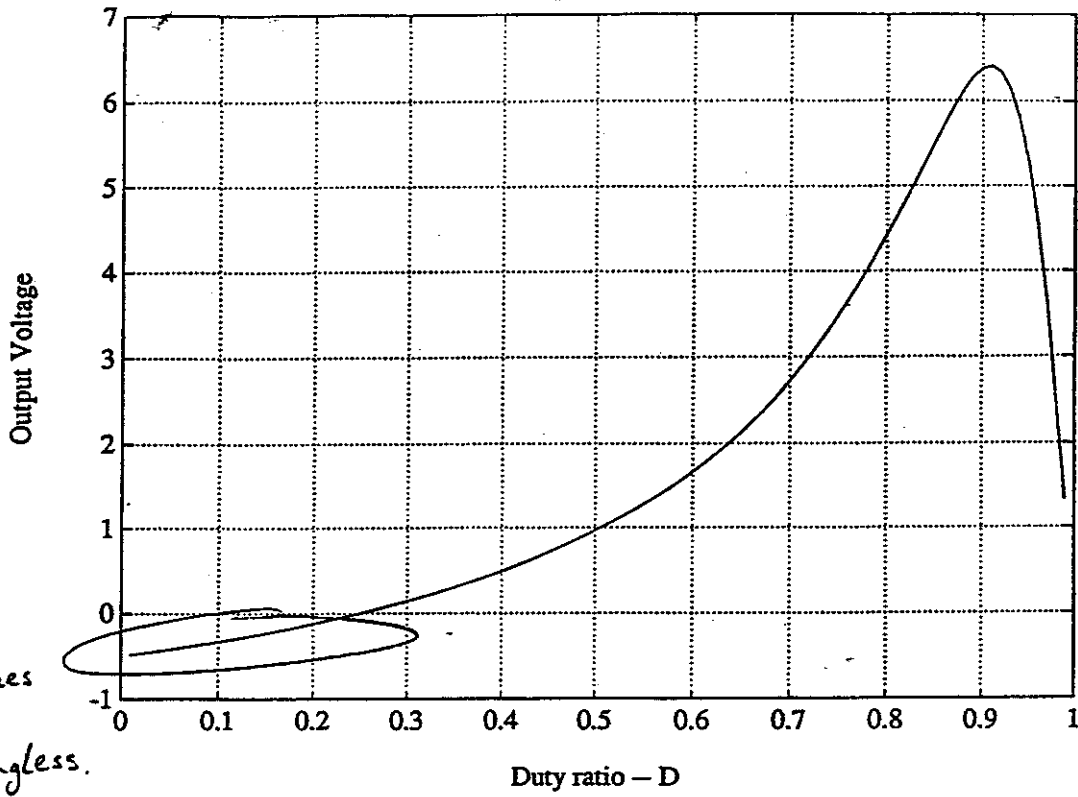

These  
-ve values  
are  
meaningless.

Efficiency

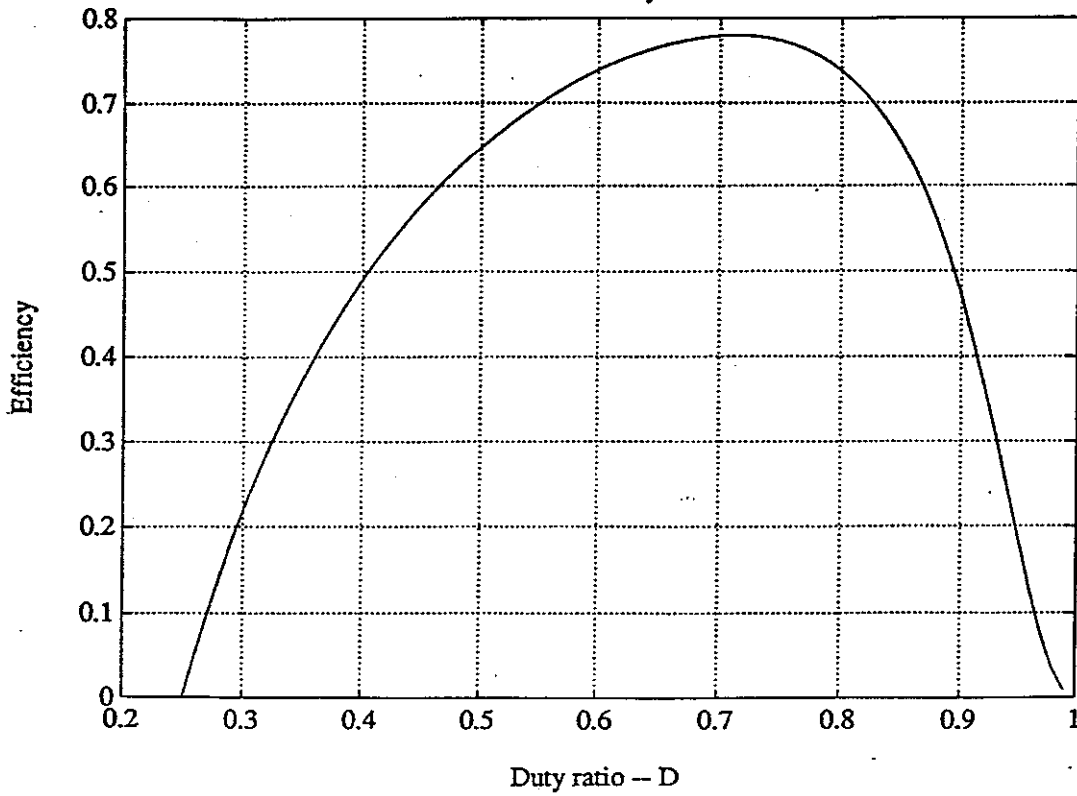

duty cycle  $D$ . This model can be easily manipulated and solved using familiar techniques of conventional circuit analysis.

2. The model can be refined to account for loss elements such as inductor winding resistance and semiconductor on-resistances and forward voltage drops. The refined model predicts the voltages, currents, and efficiency of practical nonideal converters.
3. In general, the dc equivalent circuit for a converter can be derived from the inductor volt-second balance and capacitor charge balance equations. Equivalent circuits are constructed whose loop and node equations coincide with the volt-second and charge balance equations. In converters having a pulsating input current, an additional equation is needed to model the converter input port; this equation may be obtained by averaging the converter input current.

REFERENCES

- [1] R. D. MIDDLEBROOK, "A Continuous Model for the Tapped-Inductor Boost Converter," *IEEE Power Electronics Specialists Conference, 1975 Record*, pp. 63-79, June 1975.
- [2] S. M. CUK, "Modeling, Analysis, and Design of Switching Converters," Ph.D. thesis, California Institute of Technology, November 1976.
- [3] R. D. MIDDLEBROOK and S. M. CUK, "Modeling and Analysis Methods for Dc-to-Dc Switching Converters," *IEEE International Semiconductor Power Converter Conference, 1977 Record*, pp. 90-111.

PROBLEMS

- 3.1 The inductor of a buck-boost converter has winding resistance  $R_L$ . All other losses can be ignored.
  - (a) Derive an expression for the nonideal voltage conversion ratio  $V/V_g$ .
  - (b) Plot your result of part (a) over the range  $0 \leq D \leq 1$ , for  $R_L/R = 0, 0.01, \text{ and } 0.05$ .
- 3.2 The inductor of a buck-boost converter has winding resistance  $R_L$ . All other losses can be ignored. Derive an equivalent circuit model for this converter. Your model should explicitly show the input port of the converter, and should contain two dc transformers.
- 3.3 To reduce the switching harmonics present in the input current of a certain buck converter, an input filter is added as shown in Fig. 3.30. Inductors  $L_1$  and  $L_2$  contain winding resistances  $R_{L1}$  and  $R_{L2}$ , respectively. The MOSFET has on-resistance  $R_{on}$ , and the diode forward voltage drop can be modeled by a constant voltage  $V_D$  plus a resistor  $R_D$ . All other losses can be ignored.
  - (a) Derive a complete equivalent circuit model for this circuit.
  - (b) Solve your model to find the output voltage  $V$ .
  - (c) Derive an expression for the efficiency. Manipulate your expression into a form similar to Eq. (3.35).
- 3.4 A 1.5 V battery is to be used to power a 5 V, 1 A load. It has been decided to use a buck-boost converter in this application. A suitable transistor is found with an on-resistance of 35 m $\Omega$ , and a Schottky diode is

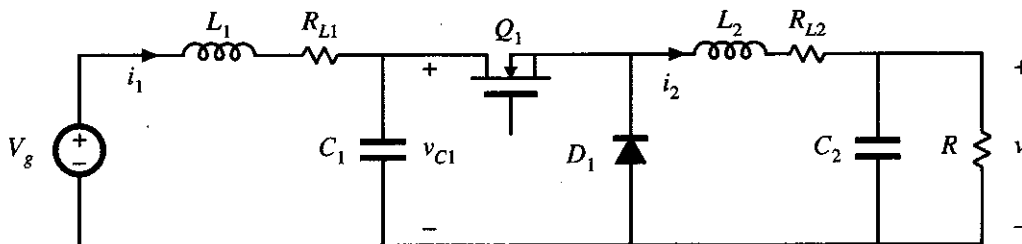

Fig. 3.30.

Fig. 3.31.

found with a ft stage schematic

- (a) Derive an diode con model sho
- (b) It is desin when the resistance not-so-eas
- (c) For your c
- (d) Plot the cc winding re
- (e) Discuss yc

For Problems 3. may neglect all on-resistance on but do not chan

3.5 It is desired to approaches, usi described above

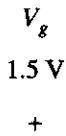

(a)

(b)

50

50

Solution to Problem 3.3

Converter circuit, Fig. 3.30:

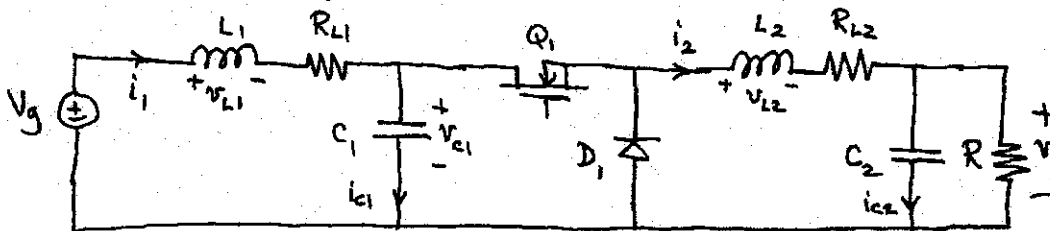

Model inductor winding resistances  $R_{L1}$  and  $R_{L2}$ , MOSFET on-resistance  $R_{on}$ , and diode forward voltage drop (constant voltage  $V_D$  plus voltage across effective resistance  $R_D$ ).

Subinterval 1  $0 < t < DT_s$ .  $Q_1$  on,  $D_1$  off

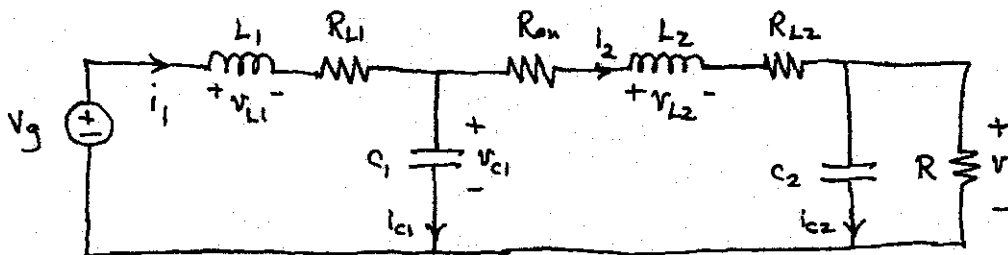

Inductor voltages and capacitor currents, expressed as functions of quantities that have small ripple:

$$v_{L1}(t) = V_g - i_1(t)R_{L1} - v_{c1}(t)$$

$$v_{L2}(t) = v_{c1}(t) - i_2(t)R_{on} - i_2(t)R_{L2} - v(t)$$

$$i_{c1}(t) = i_1(t) - i_2(t)$$

$$i_{c2}(t) = i_2(t) - v(t)/R$$

Small-ripple approximation:  $i_1(t) \approx I_1$ ,  $i_2(t) \approx I_2$ ,  $v_{c1}(t) \approx V_{c1}$ ,  $v(t) \approx V$

we get

$$v_{L1}(t) \approx V_g - I_1 R_{L1} - V_{c1}$$

$$v_{L2}(t) \approx V_{c1} - I_2 R_{L2} - V$$

$$i_{c1}(t) \approx I_1 - I_2$$

$$i_{c2}(t) \approx I_2 - V/R$$

Subinterval 2

$DT_S < t < T_S$

$Q_1$  off,  $D_1$  on

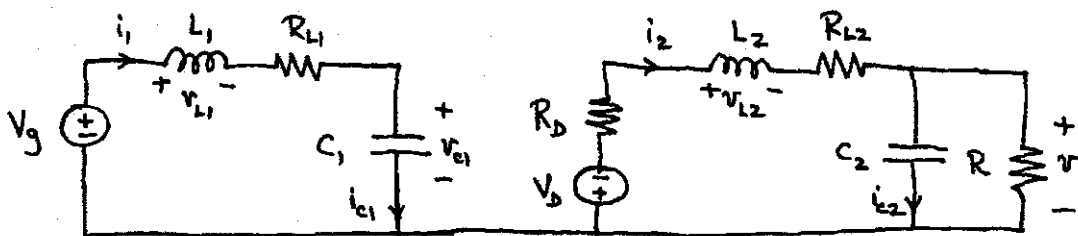

$$v_{L1}(t) = V_g - i_1(t) R_{L1} - v_{c1}(t)$$

$$v_{L2}(t) = -V_D - i_2(t) R_D - i_2(t) R_{L2} - v(t)$$

$$i_{c1}(t) = i_1(t)$$

$$i_{c2}(t) = i_2(t) - v(t)/R$$

Small ripple approximation:

$$v_{L1}(t) \approx V_g - I_1 R_{L1} - V_{c1}$$

$$v_{L2}(t) \approx -V_D - I_2 R_D - I_2 R_{L2} - V$$

$$i_{c1}(t) \approx I_1$$

$$i_{c2}(t) \approx I_2 - V/R$$

Switched waveforms:

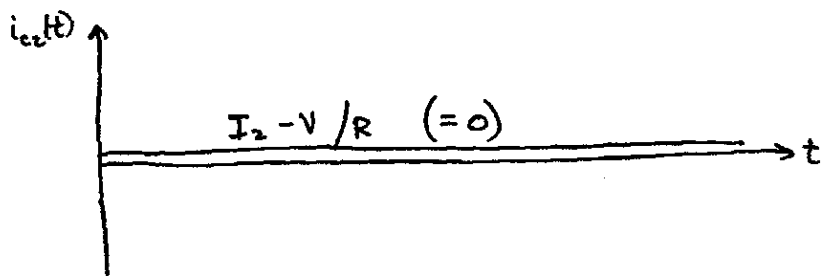
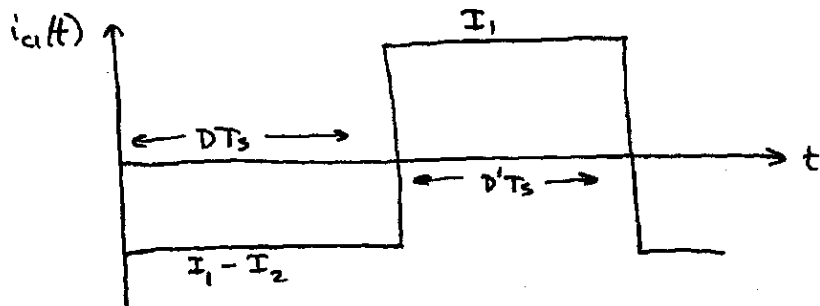
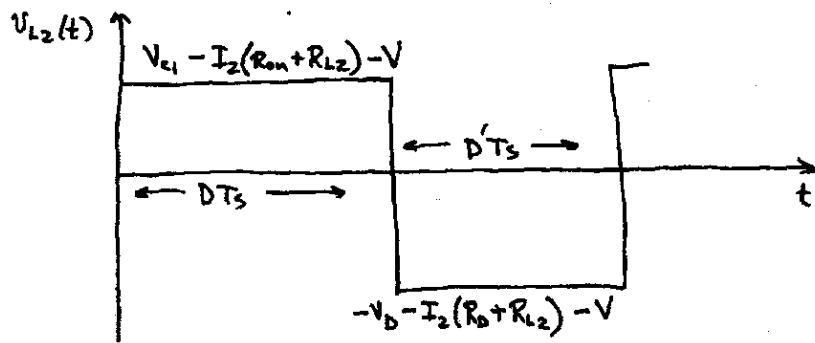
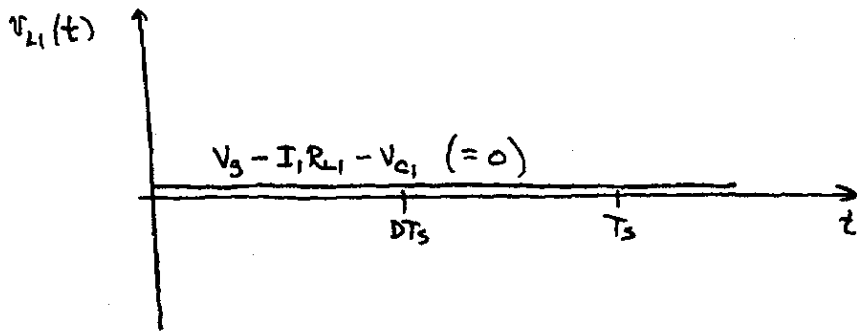

Equate average inductor voltages and capacitor currents to zero:

$$\langle v_{L_1}(t) \rangle = 0 = V_g - I_1 R_{L1} - V_{C1}$$

$$\langle v_{L_2}(t) \rangle = 0 = D[V_{C1} - I_2(R_{on} + R_{L2}) - V] + D'[-V_D - I_2(R_D + R_{L2}) - V]$$

$$\langle i_{C1}(t) \rangle = 0 = D[I_1 - I_2] + D'[I_1]$$

$$\langle i_{C2}(t) \rangle = 0 = I_2 - V/R$$

Derive equivalent circuit

Inductor  $L_1$ :  $\langle v_{L_1} \rangle = 0 = V_g - I_1 R_{L1} - V_{C1}$

A loop equation containing  $L_1$ , with current  $I_1$

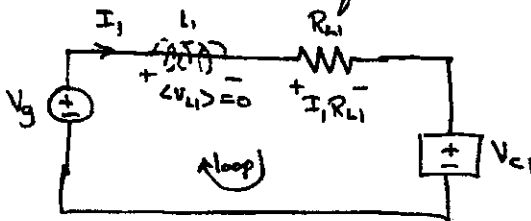

Inductor  $L_2$ :  $\langle v_{L_2} \rangle = 0 = DV_{C1} - DR_{on}I_2 - D'R_D I_2 - R_{L2}I_2 - V - D'V_D$

A loop equation containing  $L_2$ , with current  $I_2$

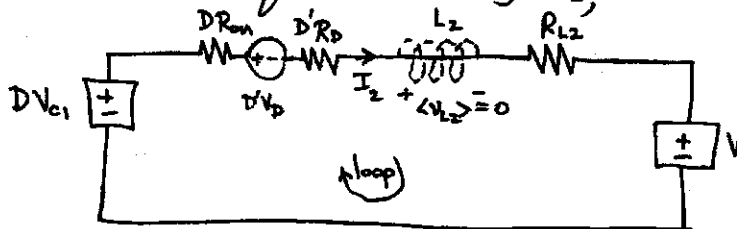

Capacitor  $C_1$  :  $\langle i_{c1} \rangle = 0 = I_1 - DI_2$

A node equation containing  $C_1$ , with voltage  $V_{c1}$

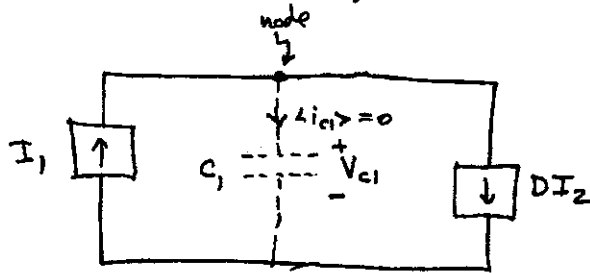

Capacitor  $C_2$  :  $\langle i_{c2} \rangle = 0 = I_2 - V/R$

A node equation including  $C_2$ , with voltage  $V$ .

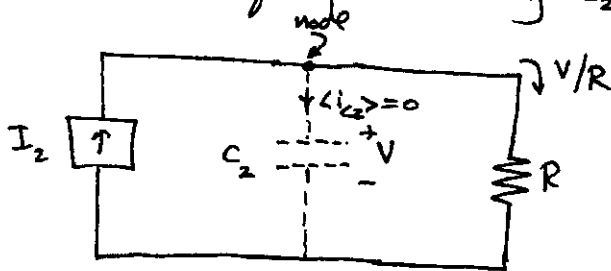



write circuits together:

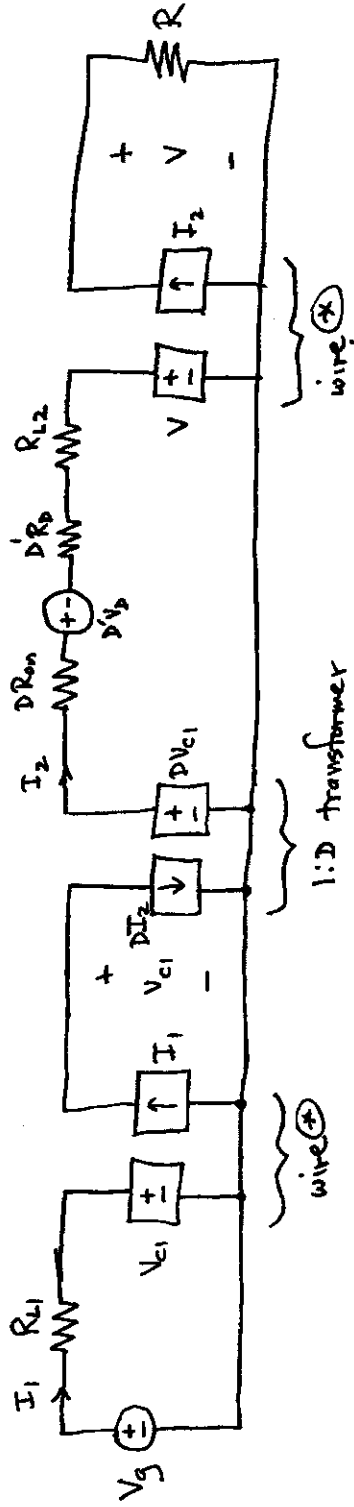

Note that 1:1 transformers are not needed in these locations - a direct connection will suffice! In fact, in the actual converter there is no switching at these points. Inductor  $L_1$  is directly connected to  $C_1$ , and  $L_2$  is always connected to  $C_2$ .

The  $D I_2$  and  $D V_{c1}$  dependent sources form a 1:1 effective dc transformer.

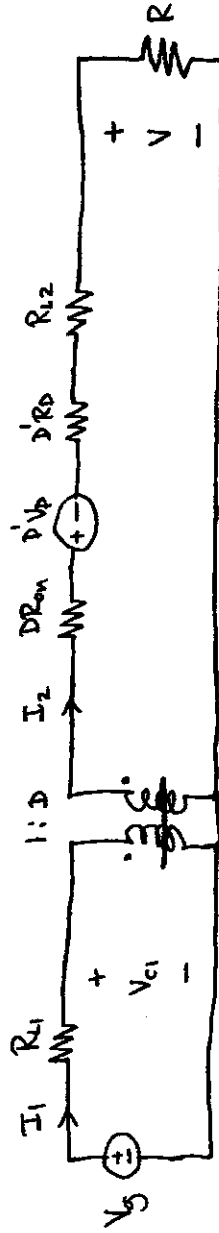

b) Solve model to find  $V$

Push  $V_g$  and  $R_{L1}$  through dc transformer:

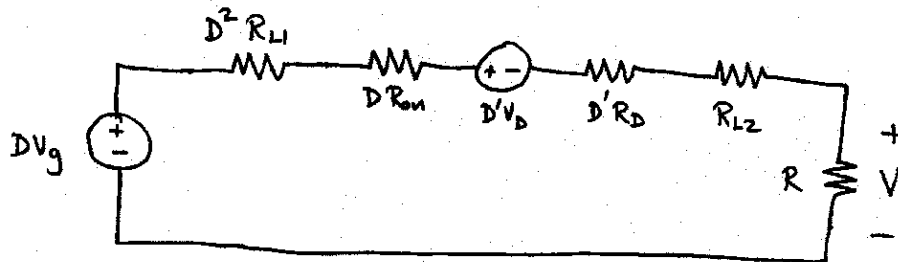

Combine elements:

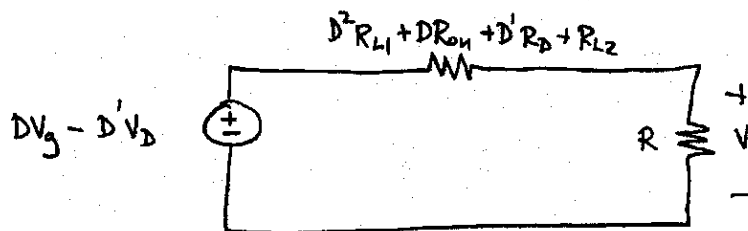

Voltage divider formula:

$$V = (DV_g - D'V_D) \frac{R}{R + D^2 R_{L1} + D R_{on} + D' R_D + R_{L2}}$$

c) Derive an expression for efficiency  $\eta$ . Manipulate into form similar to Eq. (3.35)

From the equivalent circuit on page 6,

$$P_{in} = V_g I_1$$

$$P_{out} = V I_2$$

$$\text{and } I_1 = D I_2$$

So

$$\eta = \frac{P_{out}}{P_{in}} = \frac{V I_2}{V_g I_1} = \frac{1}{D} \frac{V}{V_g}$$

From part (b),

$$\frac{V}{V_g} = \left( D - D' \frac{V_D}{V_g} \right) \frac{R}{R + D^2 R_{L1} + D R_{on} + D' R_D + R_{L2}}$$

(note that it is OK for the right side of the equation to depend on  $V_g$ ).

So

$$\eta = \left( 1 - \frac{D'}{D} \frac{V_D}{V_g} \right) \frac{1}{\left( 1 + D^2 \frac{R_{L1}}{R} + D \frac{R_{on}}{R} + D' \frac{R_D}{R} + \frac{R_{L2}}{R} \right)}$$

This is a good design-oriented way to express the efficiency, because it exposes how each loss element reduces the efficiency. The effect of the diode voltage drop  $V_D$  is expressed in terms of  $V_g$ , while the loss resistances are compared to  $R$ . The various losses also depend on duty cycle.

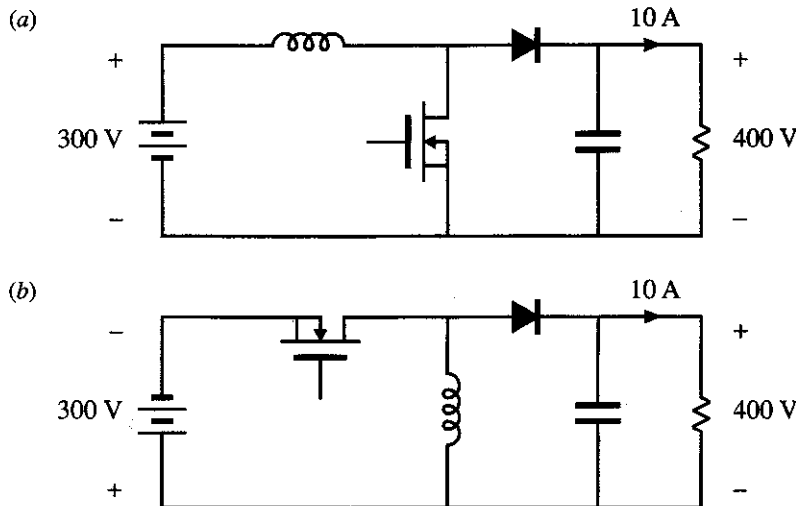

Fig. 3.33.

- (a) Derive equivalent circuit models for both converters, which model the converter input and output ports as well as the transistor conduction loss.
- (b) Determine the duty cycles that cause the converters to operate with the specified conditions.
- (c) Compare the transistor conduction losses and efficiencies of the two approaches, and conclude which converter is better suited to the specified application.



3.6 It is desired to interface a 300 V battery to a 400 V, 10 A load using a dc-dc converter. Two possible approaches, using boost and buck-boost converters, are illustrated in Fig. 3.33. Using the assumptions described above (before Problem 3.5), determine the efficiency and power loss of each approach. Which converter is better for this application?

3.7 A buck converter is operated from the rectified 230 V ac mains, such that the converter dc input voltage is

$$V_g = 325 \pm 20\%$$

A control circuit automatically adjusts the converter duty cycle  $D$ , to maintain a constant dc output voltage of  $V = 240$  V dc. The dc load current  $I$  can vary over a 10:1 range:

$$10 \text{ A} \geq I \geq 1 \text{ A}$$

The MOSFET has an on-resistance of  $0.8 \Omega$ . The diode conduction loss can be modeled by a 0.7 V source in series with a  $0.2 \Omega$  resistor. All other losses can be neglected.

- (a) Derive an equivalent circuit that models the converter input and output ports, as well as the loss elements described above.
  - (b) Given the range of variation of  $V_g$  and  $I$  described above, over what range will the duty cycle vary?
  - (c) At what operating point (i.e., at what value of  $V_g$  and  $D$ ) is the converter power loss the largest? What is the value of the efficiency at this operating point?
- 3.8 In the Cuk converter of Fig. 3.34, the MOSFET has on-resistance  $R_{on}$  and the diode has a constant forward voltage drop  $V_D$ . All other losses can be neglected.
- (a) Derive an equivalent circuit model for this converter. *Suggestion:* if you don't know how to handle some of the terms in your dc equations, then temporarily leave them as dependent sources. A more

Fig. 3.34.

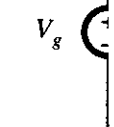

- physical re  
the model.
- (b) Derive ana
- (c) For  $V_D = 0$
- (d) For  $V_D = 0$   
 $R = 0.05$ .

Solution to Problem 3.6

Interface a 300V battery to a 400V, 10A load.  
Investigate boost and buck-boost converters; which has better efficiency?  
MOSFET has 0.5Ω on-resistance. All other losses can be ignored.

Boost converter

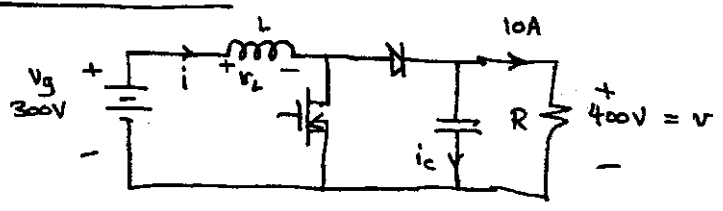

$$R = \frac{400V}{10A} = 40\Omega$$

transistor on diode off

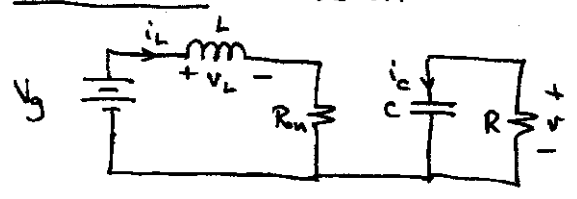

su. ripple approximation

$$v_L(t) = V_g - i_L(t)R_{on} \approx V_g - I_L R_{on}$$

$$i_c(t) = -v(t)/R \approx -\frac{V}{R}$$

transistor off diode on

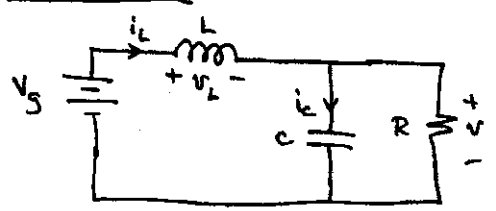

$$v_L(t) = V_g - v(t) \approx V_g - V$$

$$i_c(t) = i_L(t) - \frac{v(t)}{R} \approx I_L - \frac{V}{R}$$

Volt-second balance

$$\langle v_L(t) \rangle = 0 = D(V_g - I_L R_{on}) + D'(V_g - V) = V_g - D R_{on} I_L - D' V$$

charge balance

$$\langle i_c(t) \rangle = 0 = D\left(-\frac{V}{R}\right) + D'\left(I_L - \frac{V}{R}\right) = D' I_L - \frac{V}{R}$$

Construct equivalent circuit

inductor - loop equation  $\langle v_L \rangle = 0 = V_g - DR_{on} I_L - D'V$

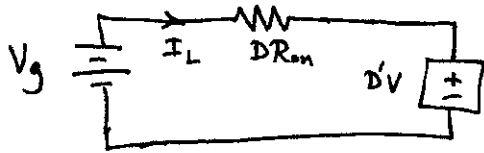

capacitor - node equation

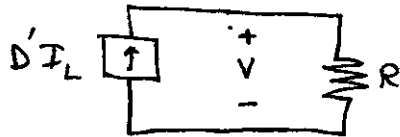

Combine circuits, replace dependent sources with  $D':1$  transformer

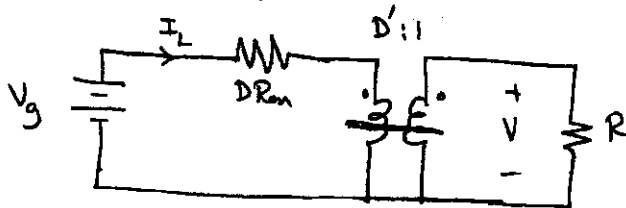

Solution:

$$V = \frac{1}{D'} V_g \frac{1}{1 + \frac{D}{(D')^2} \frac{R_{on}}{R}}$$

$$I_L = \frac{V}{DR}$$

$$\eta = \frac{1}{1 + \frac{D}{(D')^2} \frac{R_{on}}{R}}$$

$$P_{loss} = I_L^2 DR_{on}$$

For the values  $V_g = 300$ ,  $V = 400$ ,  $R = 40$ ,  $R_{on} = 0.5$

find  $D$  and  $\eta$  (and also  $I_L$  and  $P_{loss}$ )

Solve quadratic equation for  $D$  (arises from  $\frac{V}{V_g} = \frac{1}{1-D} \frac{1}{1 + \frac{D}{(1-D)^2} \frac{R_{on}}{R}}$ )

$$\Rightarrow D = 0.2543 \quad (\text{note } D \rightarrow 0.2500 \text{ for } R_{on} \rightarrow 0)$$

Then  $\eta = 0.9943$       99.43%

$I_L = 13.4A$

$P_{loss} = 22.9 W$

Buck-boost converter

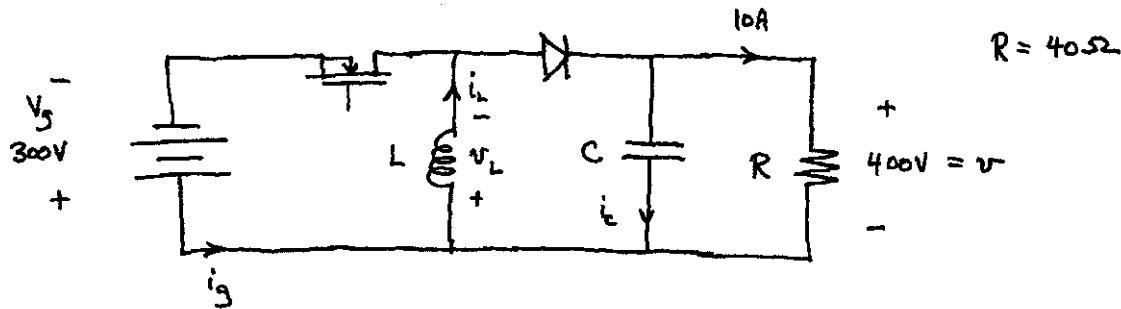

transistor on       $0 < t < DT_s$       diode off

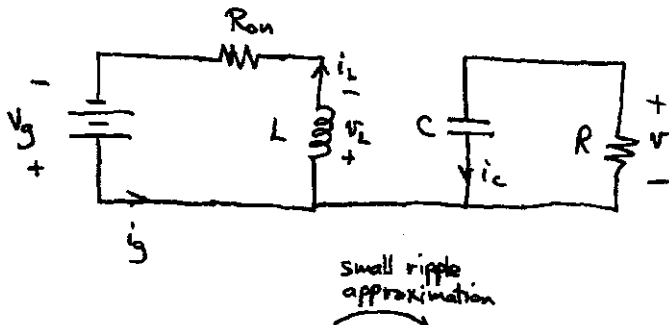

Since the converter input current  $i_g(t)$  is pulsating, we must write equations for  $i_g(t)$  during each subinterval, then average to find the dc component

$$v_L(t) = V_g - i_L R_{on} \approx V_g - I_L R_{on}$$

$$i_c(t) = -v(t)/R \approx -V/R$$

$$i_g(t) = i_L(t) \approx I_L$$

transistor off

$$DT_s < t < T_s$$

diode on

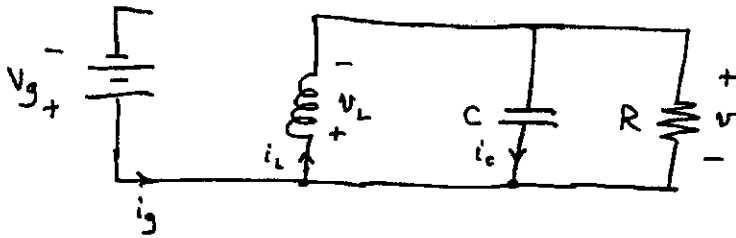

$$v_L(t) = -v(t) \approx -V$$

$$i_c(t) = i_L(t) - v(t)/R \approx I_L - V/R$$

$$i_g(t) = 0$$

Volt-second balance

$$\langle v_L(t) \rangle = 0 = D(V_g - I_L R_{on}) + D'(-V)$$

charge balance

$$\langle i_c(t) \rangle = 0 = D(-V/R) + D'(I_L - V/R)$$

average input current

$$\langle i_g \rangle = I_g = D(I_L) + D'(0)$$

Construct equivalent circuit

inductor loop equation:  $DV_g - I_L D R_{on} - D'V = \langle v_L \rangle = 0$

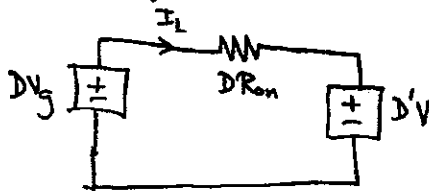



Capacitor node equation:  $D'I_L - \frac{V}{R} = \langle i_c \rangle = 0$

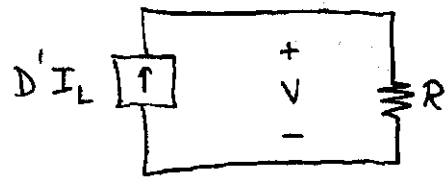

Input current (node) equation:  $I_g = DI_L$

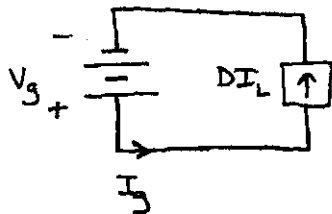

Draw circuit models together:

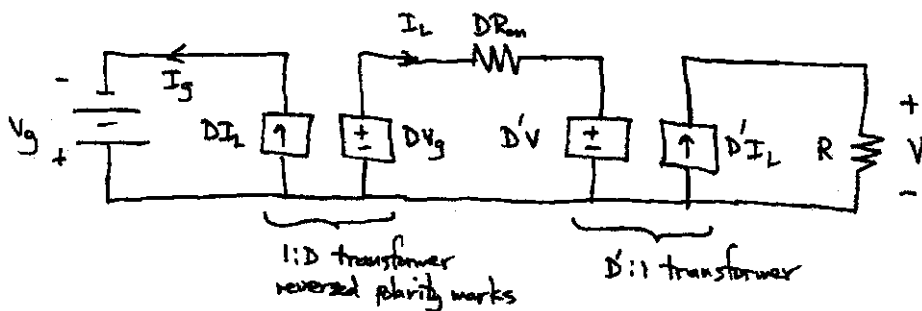

Model including ideal dc transformers:

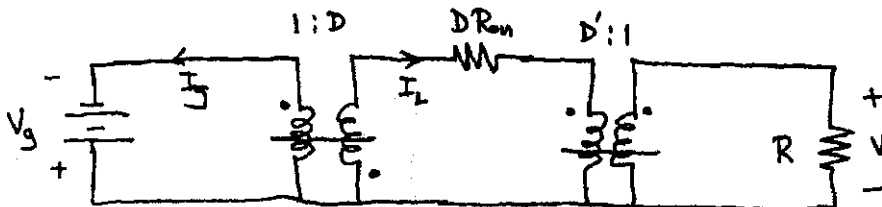

Solution of model:

$$V = \frac{D}{D'} V_g \frac{R}{R + \frac{D}{(D')^2} R_{on}} \Rightarrow \frac{V}{V_g} = \frac{D}{D'} \frac{1}{1 + \frac{D}{(D')^2} \frac{R_{on}}{R}}$$

$$\eta = \frac{1}{1 + \frac{D}{(D')^2} \frac{R_{on}}{R}}$$

$$I_L = \frac{V}{D'R}$$

$$P_{loss} = I_L^2 D R_{on}$$

Note that, with the exception of the extra factor of  $D$  in the  $\frac{V}{V_g}$  equation, all of the above equations are identical to the respective boost converter equations on page 2.

Because of the extra factor of  $D$ , the buck-boost converter must operate at a larger duty cycle. This leads to increased inductor current, increased transistor conduction time, and increased power loss.

Solution

$$D = 0.5813$$

$$\eta = 0.9602 \quad 96.02\%$$

$$I_L = 23.89 \text{ A}$$

$$P_{loss} = 165.8 \text{ W}$$

— more than 7 times larger than boost  
heatsink must be 7 times larger

boost is much better than buck-boost  
in this application

End of problem 3.6

- [11] B. J. BALIGA, *Modern Power Devices*, New York: John Wiley & Sons, 1987.
- [12] P. GRAY, D. DEWITT, A. BOOTHROYD, and J. GIBBONS, *Physical Electronics and Circuit Models of Transistors*, Semiconductor Electronics Education Committee, Vol. 2, New York: John Wiley & Sons, 1964.
- [13] E. OXNER, *Power FETs and Their Applications*, Englewood, New Jersey: Prentice-Hall, 1982.
- [14] M. RASHID, *Power Electronics: Circuits, Devices, and Applications*, 2nd edit., Englewood, New Jersey: Prentice Hall, 1993, Chapters 3, 4, and 8.
- [15] B. J. BALIGA, M. S. ADLER, R. P. LOVE, P. V. GRAY, and N. D. ZAMMER, "The Insulated Gate Transistor—A New Three Terminal MOS-Controlled Bipolar Power Device," *IEEE Transactions on Electron Devices*, Vol. 31, No. 6, pp. 821–828, June 1984.
- [16] V. TEMPLE, "MOS-Controlled Thyristors—A New Class of Power Devices," *IEEE Transactions on Electron Devices*, Vol. 33, No. 10, pp. 1609–1618, October 1986.
- [17] S. SUL, F. PROFUMO, G. CHO, and T. LIPO, "MCTs and IGBTs: A Comparison of Performance in Power Electronics Circuits," *IEEE Power Electronics Specialists Conference*, 1989 Record, pp. 163–169, June 1989.
- [18] V. TEMPLE, S. ARTHUR, D. WATROUS, R. DE DONCKER, and H. METHA, "Megawatt MOS Controlled Thyristor for High Voltage Power Circuits," *IEEE Power Electronics Specialists Conference*, 1992 Record, pp. 1018–1025, June 1992.

### PROBLEMS

In Problems 4.1 to 4.6, the input voltage  $V_g$  is dc and positive with the polarity shown. Specify how to implement the switches using a minimal number of diodes and transistors, such that the converter operates over the entire range of duty cycles  $0 \leq D \leq 1$ . The switch states should vary as shown in Fig. 4.56. You may assume that the inductor current ripples and capacitor voltage ripples are small.

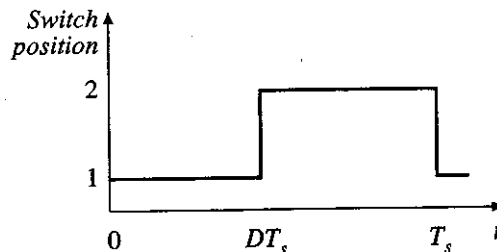

Fig. 4.56

For each problem, do the following:

- Realize the switches using SPST ideal switches, and explicitly define the voltage and current of each switch.
- Express the on-state current and off-state voltage of each SPST switch in terms of the converter inductor currents, capacitor voltages, and/or input source voltage.
- Solve the converter to determine the inductor currents and capacitor voltages, as in Chapter 2.
- Determine the polarities of the switch on-state currents and off-state voltages. Do the polarities vary with duty cycle?
- State how each switch can be realized using transistors and/or diodes, and whether the realization requires single-quadrant, current-bidirectional two-quadrant, voltage-bidirectional two-quadrant, or four-quadrant switches.

4.1

4.2

4.3

4.4

 $V_g$  $V_g$  $V_g$

4.1

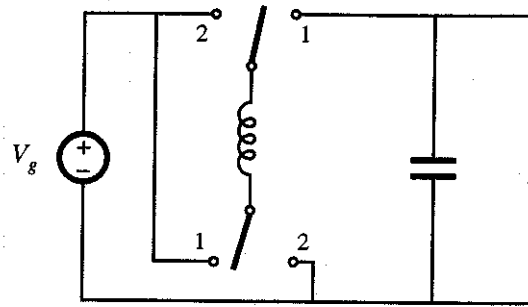

4.2

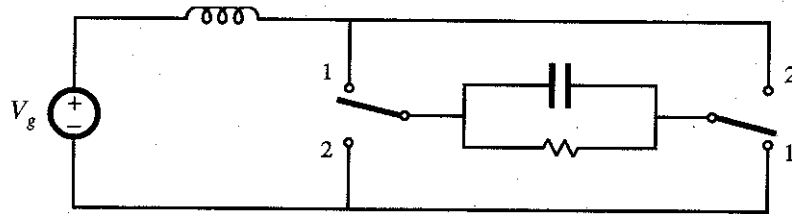

4.3

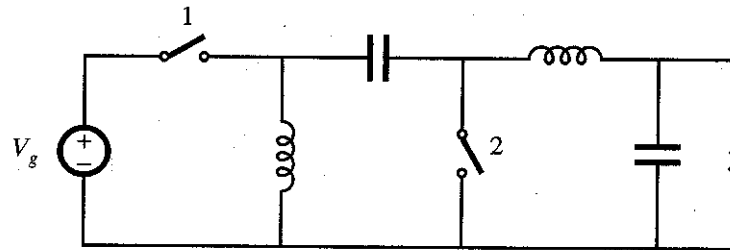

4.4

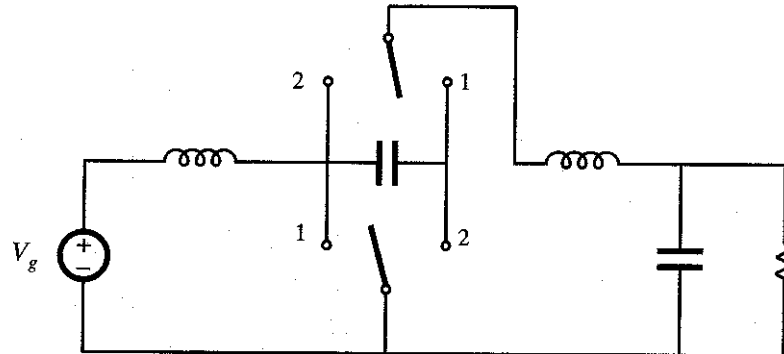

*Circuit Models of Transis-*  
*n Wiley & Sons, 1964.*

*ice-Hall, 1982.*

*, Englewood, New Jersey:*

*: Insulated Gate Transistor*  
*Transactions on Electron*

*E Transactions on Electron*

*of Performance in Power*  
*Record, pp. 163-169, June*

*MOS Controlled Thyristor*  
*ference, 1992 Record, pp.*

Specify how to implement  
er operates over the entire  
You may assume that the

voltage and current of each

in terms of the converter

es, as in Chapter 2.

ges. Do the polarities vary

nd whether the realization  
ectional two-quadrant, or

Solution to problem 4.4

R.W. Erickson  
Fundamentals of  
Power Electronics

Realize switches using transistors and diodes, such that the converter operates in CCM over the entire range  $0 \leq D \leq 1$ . The inductor current ripples and capacitor voltage ripples are small.

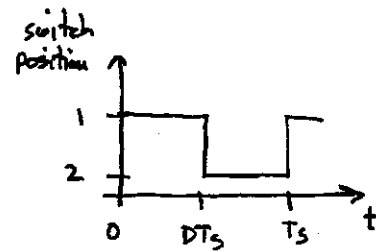
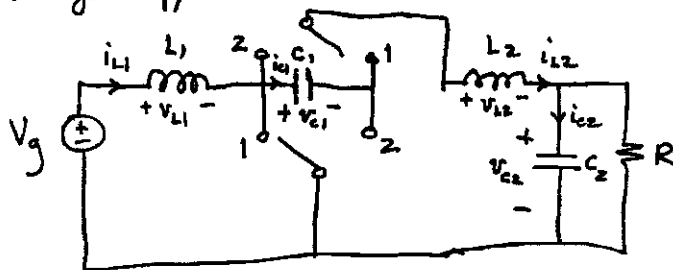

a) Realize the switches using SPST ideal switches, and explicitly define the voltage and current of each switch

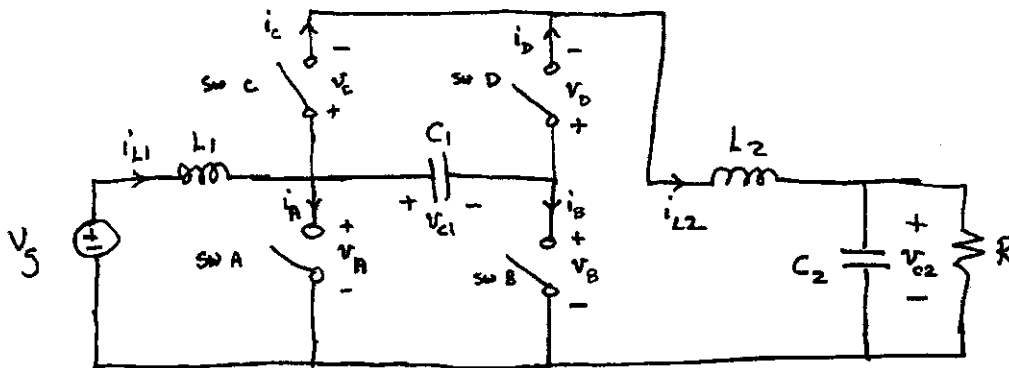

Polarity of switch voltage can be arbitrarily defined. Switch current polarity must then be defined to flow through switch from + terminal to - terminal.

subinterval 1: sw A and sw D are closed

subinterval 2: sw B and sw C are closed

b) Express the on-state current and off-state voltage of each switch in terms of the converter inductor currents, capacitor voltages, and independent sources.

Switch A

$$\text{on state: } i_A = i_{L1} - i_{L2}, v_A = 0 \quad (\text{subinterval 1})$$

$$\text{off state: } v_A = v_{c1}, i_A = 0 \quad (\text{subinterval 2})$$

Switch B

$$\text{on state: } i_B = i_{L1} - i_{L2}, v_B = 0 \quad (\text{subinterval 2})$$

$$\text{off state: } v_B = -v_{c1}, i_B = 0 \quad (\text{subinterval 1})$$

Switch C

$$\text{on state: } i_C = i_{L2}, v_C = 0 \quad (\text{subinterval 2})$$

$$\text{off state: } v_C = v_{c1}, i_C = 0 \quad (\text{subinterval 1})$$

Switch D

$$\text{on state: } i_D = i_{L2}, v_D = 0 \quad (\text{subinterval 1})$$

$$\text{off state: } v_D = -v_{c1}, i_D = 0 \quad (\text{subinterval 2})$$

(2)

c) Solve the converter to determine the dc components of the inductor currents and capacitor voltages, as in chapter 2.

Inductor voltage and capacitor current waveforms, using small ripple approximation:

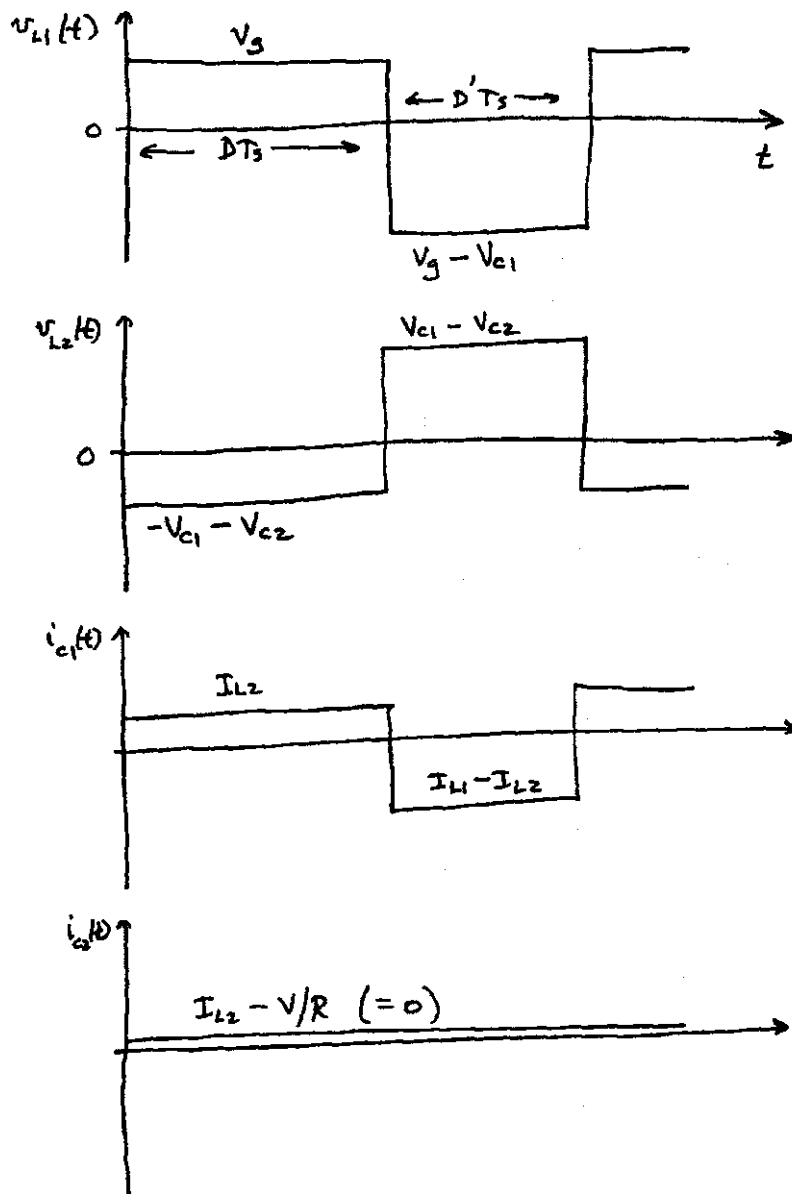

③

Volt-second balance on  $L_1$ :  $\langle v_{L1} \rangle = 0 = DV_g + D'(V_g - V_{c1})$

Volt-second balance on  $L_2$ :  $\langle v_{L2} \rangle = 0 = D(-V_{c1} - V_{c2}) + D'(V_{c1} - V_{c2})$

Charge balance on  $C_1$ :  $\langle i_{c1} \rangle = 0 = DI_{L2} + D'(I_{L1} - I_{L2})$

Charge balance on  $C_2$ :  $\langle i_{c2} \rangle = 0 = I_{L2} - V/R$

Solution:

$$V_{c1} = \frac{1}{D'} V_g$$

$$V_{c2} = (D' - D) V_{c1} = \frac{D' - D}{D'} V_g = \frac{1 - 2D}{1 - D} V_g$$

$$I_{L2} = \frac{V}{R} = \frac{1 - 2D}{1 - D} \frac{V_g}{R}$$

$$I_{L1} = \frac{D' - D}{D'} I_{L2} = \left( \frac{1 - 2D}{1 - D} \right)^2 \frac{V_g}{R}$$

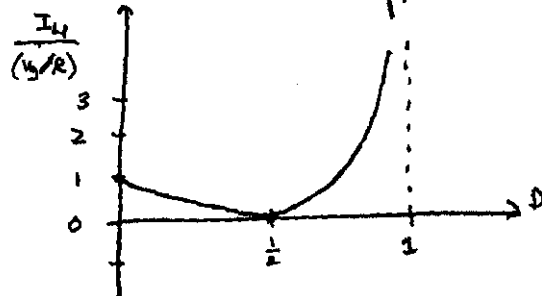
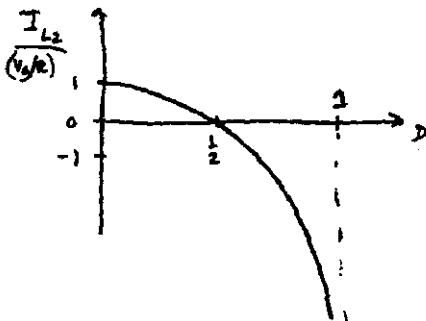
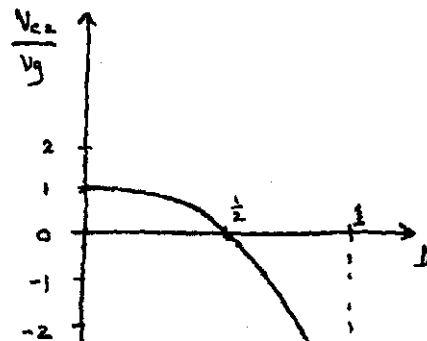
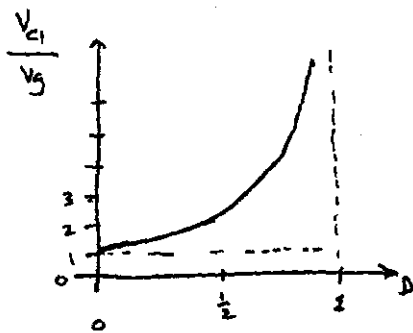

(4)



d) Polarities of switch voltages and current vs. duty cycle D

Switch A

on state:  $i_A = i_{L1} - i_{L2} = \left(\frac{1-2D}{1-D}\right)^2 \frac{V_S}{R} - \frac{1-2D}{1-D} \frac{V_S}{R}$

$$= \frac{1-2D}{1-D} \frac{V_S}{R} \left(\frac{1-2D}{1-D} - 1\right)$$

$$= \frac{V_S}{R} \frac{1-2D}{1-D} \frac{1-2D-(1-D)}{1-D}$$

$$= \frac{V_S}{R} (1-2D) \frac{(-D)}{(1-D)^2}$$

negative for  $D < \frac{1}{2}$ , positive for  $D > \frac{1}{2}$

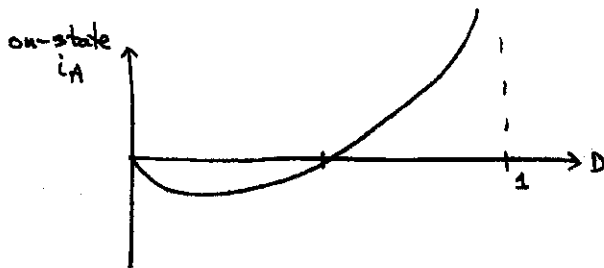

off-state:  $v_A = v_{c1} = \frac{1}{1-D} V_S$

positive for  $0 \leq D \leq 1$

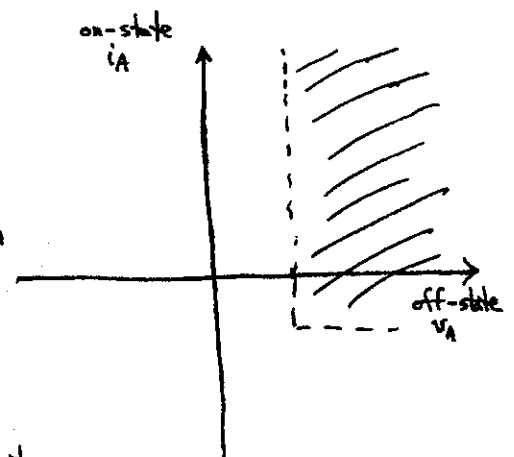
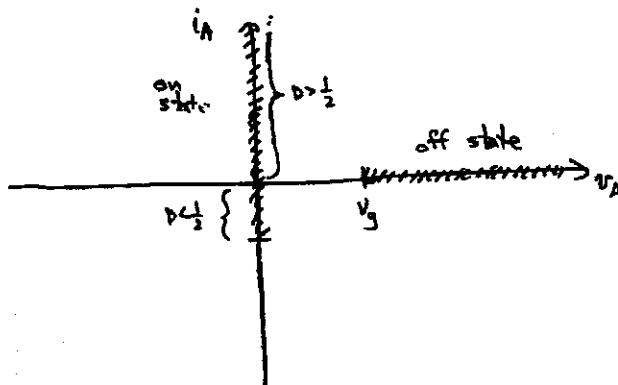

Requires a current-bidirectional two-quadrant switch:

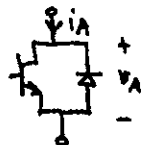

Switch B

on state:  $i_B = i_{L1} - i_{L2} = \frac{V_g}{R} (1-2D) \frac{(-D)}{(1-D)^2}$

same as switch A.

negative for  $D < \frac{1}{2}$ , positive for  $D > \frac{1}{2}$

off state:  $v_B = -v_{a1} = -\frac{1}{1-D} V_g$

negative for  $0 \leq D \leq 1$

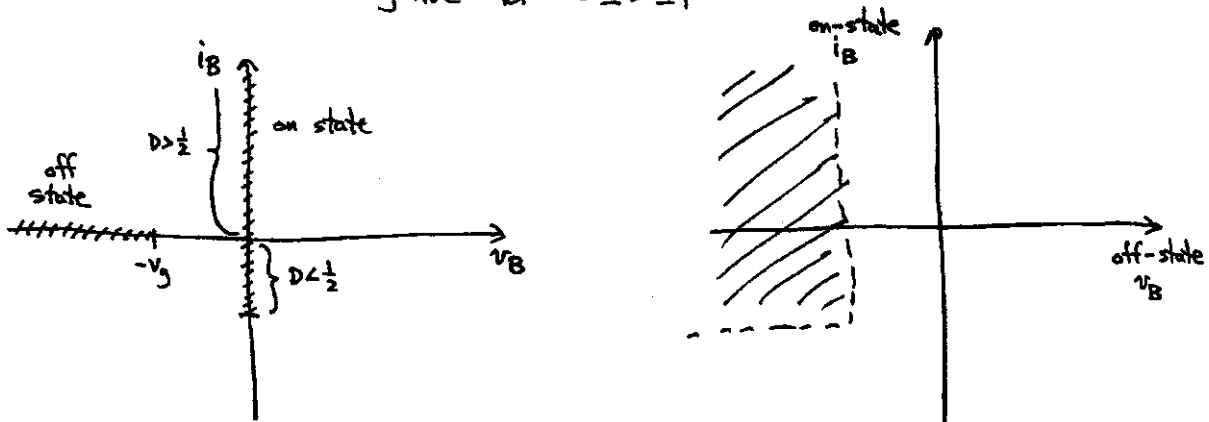

Requires a current-bidirectional two-quadrant switch that blocks negative  $v_B$ :

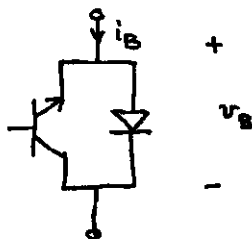

(6)

(Note: if we had originally defined  $v_B$  and  $i_B$  with the opposite polarity, then we would have obtained a current-bidirectional two-quadrant switch having the same polarity and realization as switch A)

Switch C

on state:  $i_c = i_{L2} = \frac{1-2D}{1-D} \frac{V_g}{R}$

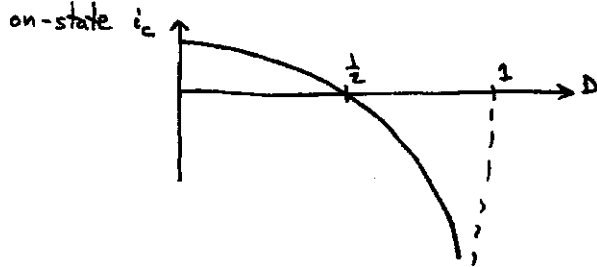

positive for  $D < \frac{1}{2}$   
negative for  $D > \frac{1}{2}$

off state:  $v_c = v_{c1} = \frac{1}{1-D} V_g$

positive for  $0 \leq D \leq 1$

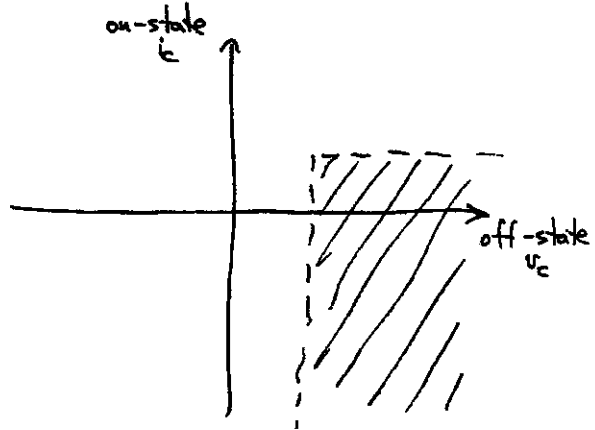
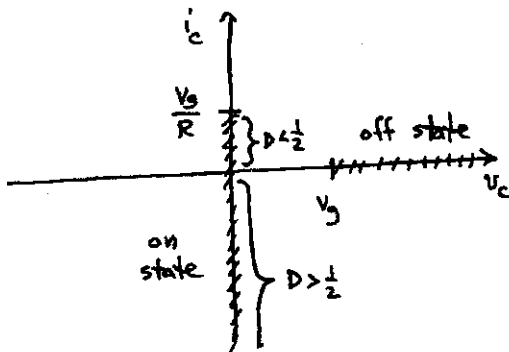

Requires a current-bidirectional  
two-quadrant switch:

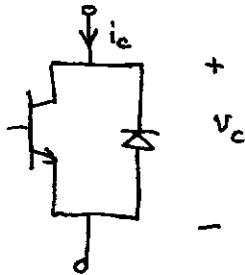

switch D

on state:  $i_D = i_{L2} = \frac{1-2D}{1-D} \frac{V_g}{R}$  positive for  $D < \frac{1}{2}$   
 negative for  $D > \frac{1}{2}$   
 (same as switch C)

off state:  $v_D = -v_{c1} = -\frac{1}{1-D} V_g$  negative for  $0 \leq D \leq 1$

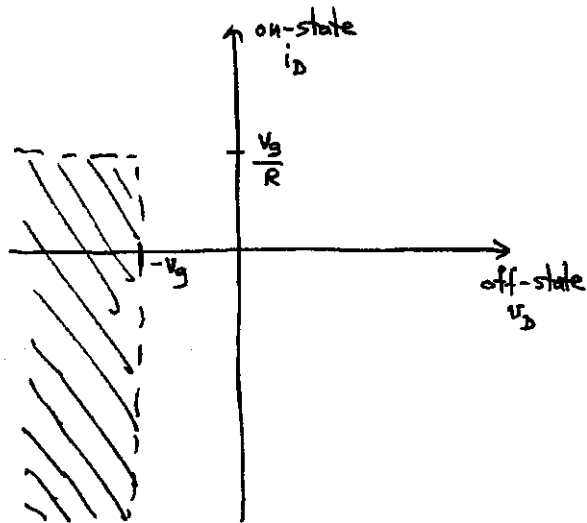
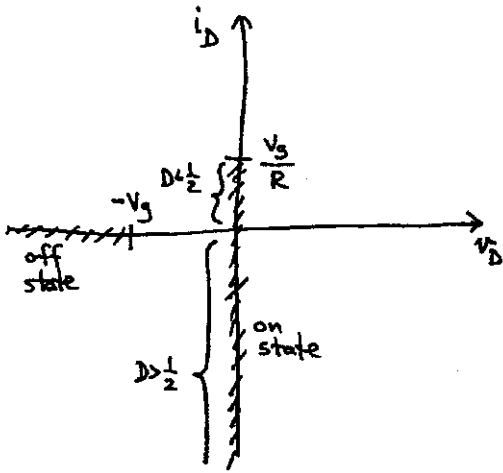

Requires a current-bidirectional two-quadrant switch that blocks negative voltage:

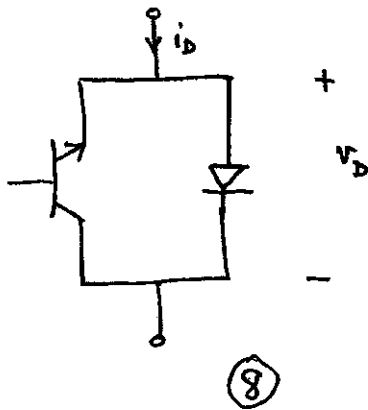

e) Implement switches in converter:

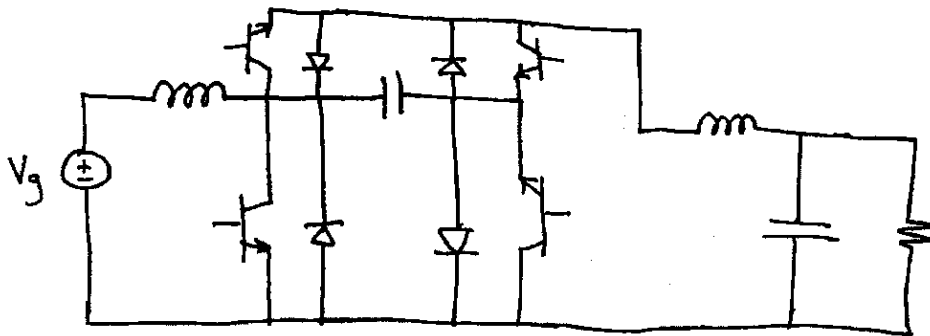

Of course, instead of BJTs, other devices such as MOSFETs or IGBTs could be used.

End of problem 4.4

EE445 / EE545

HW DCM

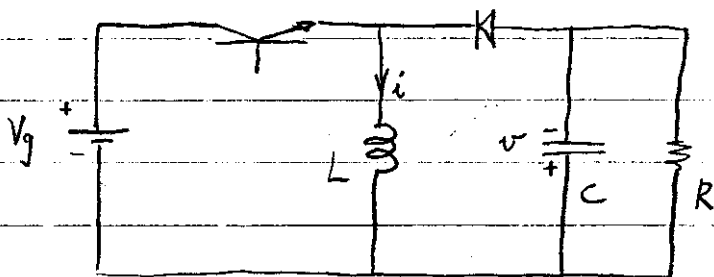

- 1) For the buck-boost converter shown above, derive an expression for  $K_{crit}(D)$ , the boundary value of  $K \equiv \frac{2L}{RT_s}$ , between the two inductor current conduction modes of the converter.
- 2) Derive an expression for the voltage gain,  $M(D, K) \equiv \frac{V}{V_g}$ , of the converter operating in DCM, by using volt-sec. and amp-sec. balance considerations on the inductor and capacitor, respectively.
- 3) Redo (2) but now by equating input and output powers assuming 100% efficiency.
- 4) For  $L = 1 \text{ mH}$ ,  $C = 1 \mu\text{F}$ ,  $T_s = \frac{1}{80 \times 10^3}$ ,  $V_g = 15$  and  $D = 0.3$ , determine the critical value of load resistance  $R_{crit}$  for which the converter operates in DCM.
- 5) Plot the dc gain as a function of load resistance  $R$  for a range of  $R \in [50 \Omega, 500 \Omega]$  and for the values given in (4).

# SOLUTION

EE445 / EE545

## HW DCM

### DISCONTINUOUS CONDUCTION IN BUCK-BOOST CONVERTER

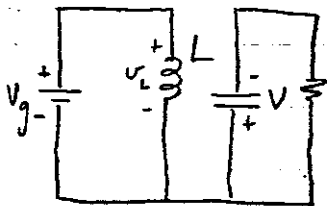

DURING  $D_1 T_s$

$$v_L = V_g$$

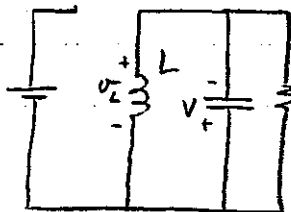

DURING  $D_2 T_s$

$$v_L = -V$$

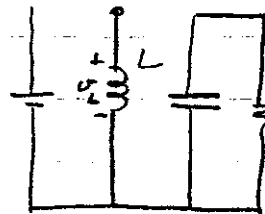

DURING  $D_3 T_s$

$$v_L = 0$$

### 1) BOUNDARY BETWEEN MODES

$$\text{CCM: } \Delta i = \frac{D T_s V_g}{2L}$$

( $\Delta i$  = peak ripple in  $L$ )

$$I_L = \frac{V}{D'R} \quad \text{average inductor current}$$

BOUNDARY :

$$I_L > \Delta i \quad \text{for CCM}$$

$$I_L < \Delta i \quad \text{for DCM}$$

$$\Rightarrow \frac{V}{D'R} > \frac{D T_s V_g}{2L}$$

$$V = \frac{D}{D'} V_g \quad \text{in CCM}$$

$$\Rightarrow \frac{D}{D'^2} \frac{V_g}{R} > \frac{D T_s V_g}{2L}$$

or  $\frac{2L}{RT_s} > D^2$

$K > K_{crit}(D)$  for CCM

$K_{crit} = D^2$

(1)

2) VOLTAGE GAIN IN DCM

VOLT-SEC BALANCE ON L  $\Rightarrow$

$$D V_g - D_2 V = 0 \Rightarrow V = \frac{D}{D_2} V_g \quad (2)$$

AMP-SEC BALANCE IN  $C_2 \Rightarrow \langle i_C \rangle = 0$

$$i_D = i_C + i_R$$

$$\Rightarrow \langle i_D \rangle = \langle i_R \rangle = \frac{V}{R}$$

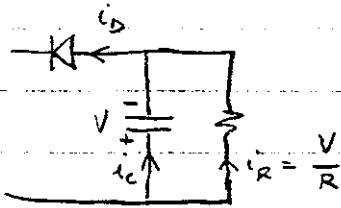

$$\langle i_D \rangle = \frac{1}{T_s} \int_0^{T_s} i_D(t) dt$$

$$= \frac{1}{T_s} \cdot \left( \frac{1}{2} i_{peak} D_2 T_s \right)$$

$$= \frac{1}{T_s} \left( \frac{D_2^2 T_s^2 V}{2L} \right)$$

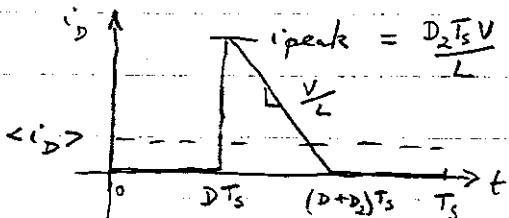



$$\Rightarrow \frac{V}{R} = \frac{D_2^2 T_s V}{2L}$$

$$\Rightarrow D_2 = \sqrt{\frac{2L}{RT_s}} = \sqrt{K} \quad (3)$$

$$(2) + (3) \Rightarrow \boxed{\frac{V}{V_g} = \frac{D}{\sqrt{K}}} \quad (4)$$

### 3) ALTERNATIVE METHOD

Note an alternative method for finding  $\frac{V}{V_g}$  may be given by equating input and output powers when assuming 100% efficiency.

$$\therefore \text{input power} = \text{output power}$$

$$\Rightarrow V_g I_{inAVE} = \frac{V^2}{R} \quad (5)$$

$$I_{inAVE} = \frac{1}{T_s} \int_0^{T_s} i_{in}(\tau) d\tau$$

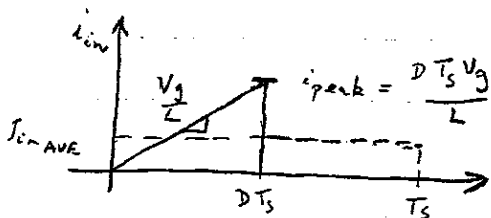

$$= \frac{1}{T_s} \left[ \frac{1}{2} i_{peak} D T_s \right]$$

$$= \frac{D^2 T_s V_g}{2L} \quad (6)$$

(5) \* (6)  $\Rightarrow$

$$\frac{D^2 T_s V_g^2}{2L} = \frac{v^2}{R}$$

$\Rightarrow$

$$\frac{v}{V_g} = \frac{D}{\sqrt{K}}, \quad K = \frac{2L}{RT_s}$$

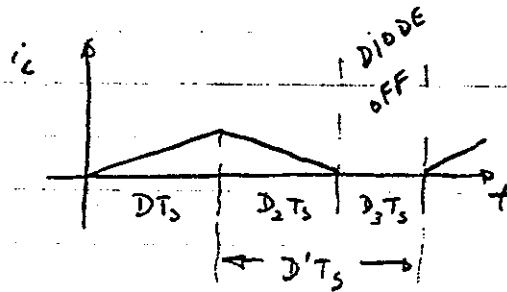

A) From (1)

$$R_{crit} = (1-D)^2 \checkmark$$

$$\Rightarrow \frac{2L}{R_{crit} T_s} = (1-D)^2$$

$$\Rightarrow R_{crit} = \frac{2L f_s}{(1-D)^2}$$

$$L = 10^{-3} \text{ H} ; f_s = 80 \times 10^3 ; D = 0.3$$

$$\Rightarrow R_{crit} = \frac{2 \times 10^{-3} \times 80 \times 10^3}{(1-0.3)^2}$$

$$\Rightarrow R_{crit} = 327 \Omega \checkmark$$

5)  $R \quad \frac{V}{V_g} \Big|_{D=0.3}$

50  
100  
150  
200  
250  
300

CCM

$$\frac{V}{V_g} = \frac{D}{1-D}$$

$$= \frac{0.3}{1-0.3} = 0.43$$

350	0.44
400	0.47
450	0.50
500	0.53

DCM

From (4)

$$\frac{V}{V_g} = \frac{D}{\sqrt{\frac{2L \cdot f_s}{R}}}$$

Converter operates in CCM for  $R < R_{crit}$  ( $R < 327\Omega$ )

Converter operates in DCM for  $R > R_{crit}$  ( $R > 327\Omega$ )

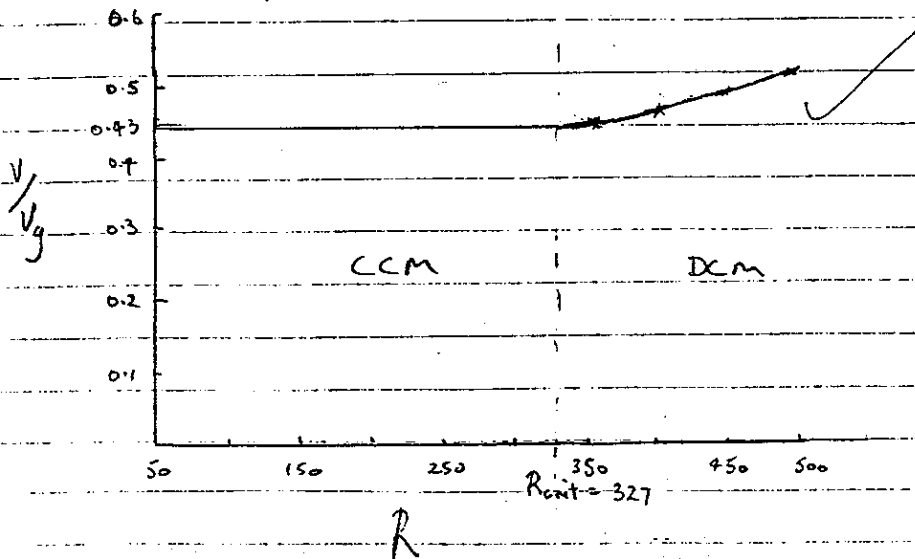

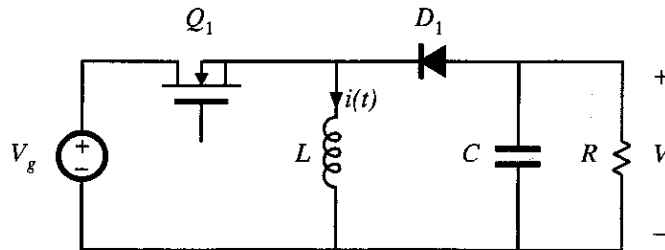

Fig. 5.21.

- (b) The load resistance is disconnected ( $R \rightarrow \infty$ ), and the converter is operated with duty cycle 0.5. Sketch the inductor current waveform.
- 5.3 An unregulated dc input voltage  $V_g$  varies over the range  $35 \text{ V} \leq V_g \leq 70 \text{ V}$ . A buck converter reduces this voltage to 28 V; a feedback loop varies the duty cycle as necessary such that the converter output voltage is always equal to 28 V. The load power varies over the range  $10 \text{ W} \leq P_{load} \leq 1000 \text{ W}$ . The element values are:

$$L = 22 \mu\text{H} \quad C = 470 \mu\text{F} \quad f_s = 75 \text{ kHz}$$

Losses may be ignored.

- (a) Over what range of  $V_g$  and load current does the converter operate in CCM?  
 (b) Determine the maximum and minimum values of the steady-state transistor duty cycle.
- 5.4 The transistors in the converter of Fig. 5.22 are driven by the same gate drive signal, so that they turn on and off in synchronism with duty cycle  $D$ .

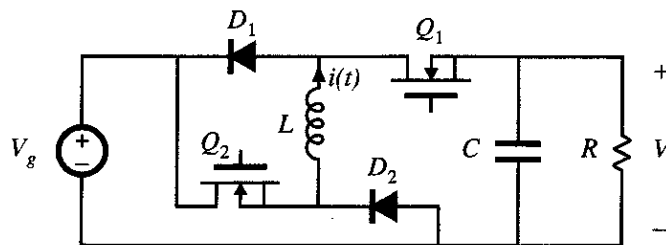

Fig. 5.22.

- (a) Determine the conditions under which this converter operates in the discontinuous conduction mode as a function of the steady-state duty ratio  $D$  and the dimensionless parameter  $K = 2L/RT_s$ .  
 (b) What happens to your answer to part (a) for  $D < 0.5$ ?  
 (c) Derive an expression for the dc conversion ratio  $M(D, K)$ . Sketch  $M$  vs.  $D$  for  $K = 10$  and for  $K = 0.1$  over the range  $0 \leq D \leq 1$ .

- 5.5 DCM mode boundary analysis of the Cuk converter of Fig. 5.23. The capacitor voltage ripples are small.  
 (a) Sketch the diode current waveform for CCM operation. Find its peak value, in terms of the ripple magnitudes  $\Delta i_{L1}$ ,  $\Delta i_{L2}$ , and the dc components  $I_1$  and  $I_2$ , of the two inductor currents  $i_{L1}(t)$  and  $i_{L2}(t)$  respectively.  
 (b) Derive an expression for the conditions under which the Cuk converter operates in the discontinuous conduction mode. Express your result in the form  $K < K_{crit}(D)$ , and give formulas for  $K$  and  $K_{crit}(D)$ .
- 5.6 DCM conversion ratio analysis of the Cuk converter of Fig. 5.23.  
 (a) Suppose that the converter operates at the boundary between CCM and DCM, with the following element and parameter values:

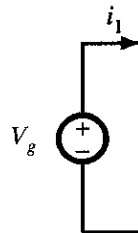

Fig. 5.23.

Sketch the diode magnitudes of the

- (b) Suppose next that of parameter and  
 (c) Sketch the diode c in the discontinu

5.7 DCM mode boundary

- (a) Sketch the diode magnitudes  $\Delta i_{L1}$ , respectively.

- (b) Derive an express ion mode. Expre

5.8 DCM conversion ratio

- (a) Suppose that the element and para

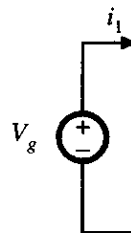

Fig. 5.24

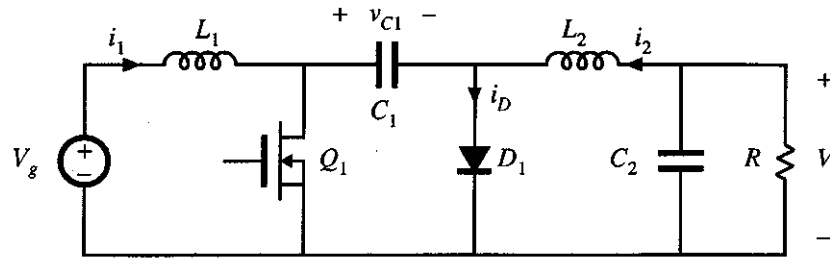

Fig. 5.23.

$$\begin{aligned}
 D &= 0.4 & f_s &= 100 \text{ kHz} \\
 V_g &= 120 \text{ V} & R &= 10 \ \Omega \\
 L_1 &= 54 \ \mu\text{H} & L_2 &= 27 \ \mu\text{H} \\
 C_1 &= 47 \ \mu\text{F} & C_2 &= 100 \ \mu\text{F}
 \end{aligned}$$

Sketch the diode current waveform  $i_D(t)$ , and the inductor current waveforms  $i_1(t)$  and  $i_2(t)$ . Label the magnitudes of the ripples and dc components of these waveforms.

- (b) Suppose next that the converter operates in the discontinuous conduction mode, with a different choice of parameter and element values. Derive an analytical expression for the dc conversion ratio  $M(D, K)$ .
- (c) Sketch the diode current waveform  $i_D(t)$ , and the inductor current waveforms  $i_1(t)$  and  $i_2(t)$ , for operation in the discontinuous conduction mode.

5.7 DCM mode boundary analysis of the SEPIC of Fig. 5.24

- (a) Sketch the diode current waveform for CCM operation. Find its peak value, in terms of the ripple magnitudes  $\Delta i_{L1}$ ,  $\Delta i_{L2}$ , and the dc components  $I_1$  and  $I_2$ , of the two inductor currents  $i_{L1}(t)$  and  $i_{L2}(t)$ , respectively.
- (b) Derive an expression for the conditions under which the SEPIC operates in the discontinuous conduction mode. Express your result in the form  $K < K_{crit}(D)$ , and give formulas for  $K$  and  $K_{crit}(D)$ .

5.8 DCM conversion ratio analysis of the SEPIC of Fig. 5.24.

- (a) Suppose that the converter operates at the boundary between CCM and DCM, with the following element and parameter values:

$$\begin{aligned}
 D &= 0.4 & f_s &= 100 \text{ kHz} \\
 V_g &= 120 \text{ V} & R &= 10 \ \Omega \\
 L_1 &= 50 \ \mu\text{H} & L_2 &= 75 \ \mu\text{H} \\
 C_1 &= 47 \ \mu\text{F} & C_2 &= 200 \ \mu\text{F}
 \end{aligned}$$

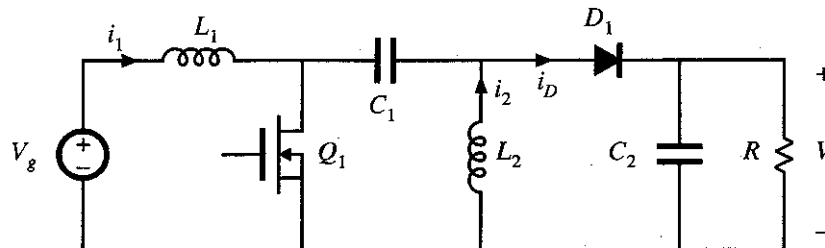
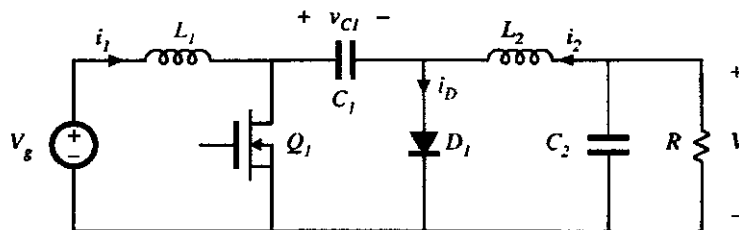

Fig. 5.24

Solution to Problem 5.5  
DCM mode boundary analysis  
of the Cuk converter

R. W. Erickson  
Fundamentals of  
Power Electronics



CCM analysis of the Cuk converter is given in Section 2.4. Some results:

$$V_{C1} = \frac{V_g}{D}$$

$$V = -\frac{D}{D'} V_g$$

$$I_1 = \left(\frac{D}{D'}\right)^2 \frac{V_g}{R}$$

$$I_2 = \frac{D}{D'} \frac{V_g}{R}$$

(note that the polarity of  $i_2$  is reversed in section 2.4, and the quantities  $v_{C1}$  and  $V$  are called  $V_1$  and  $V_2$  respectively).

Inductor current ripples (from Eq. (2.57)):

$$\Delta i_1 = \frac{V_g D T_s}{2L_1}$$

$$\Delta i_2 = \frac{V_g D T_s}{2L_2}$$

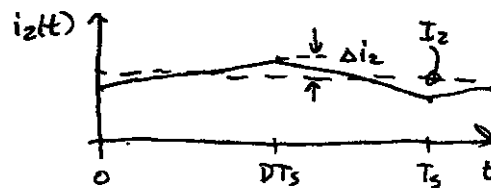
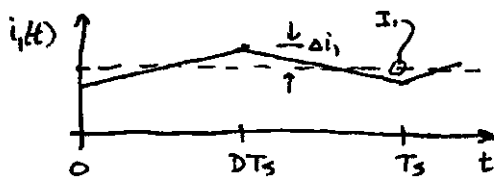

a) Sketch diode current waveform

$$i_D(t) = \begin{cases} 0 & \text{during subinterval 1 (diode off)} \\ i_1(t) + i_2(t) & \text{during subinterval 2 (transistor off)} \end{cases}$$

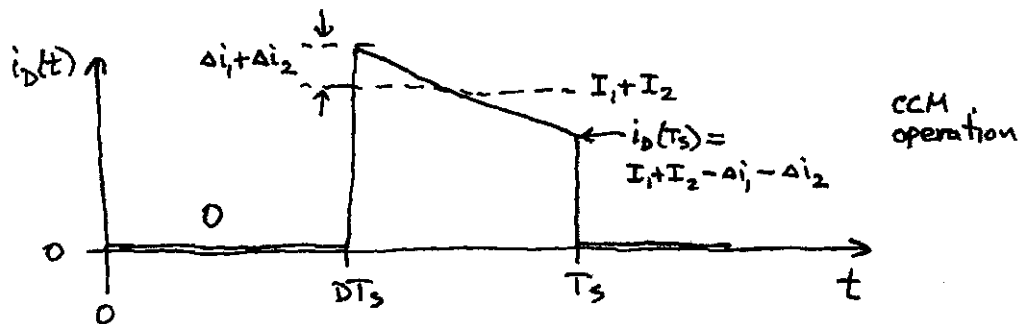

peak  $i_D(t) = I_1 + I_2 + \Delta i_1 + \Delta i_2$

b) CCM/DCM mode boundary

The dc components of inductor currents,  $I_1$  and  $I_2$ , depend on the load resistance  $R$ . The inductor current ripples,  $\Delta i_1$  and  $\Delta i_2$ , do not depend on the load resistance  $R$ . When we increase  $R$ ,  $(I_1 + I_2)$  decreases but  $(\Delta i_1 + \Delta i_2)$  does not change. If we increase  $R$  such that  $(I_1 + I_2) = (\Delta i_1 + \Delta i_2)$ , then the diode current will be zero at the end of the switching period:  $i_D(T_s) = (I_1 + I_2) - (\Delta i_1 + \Delta i_2) = 0$ .

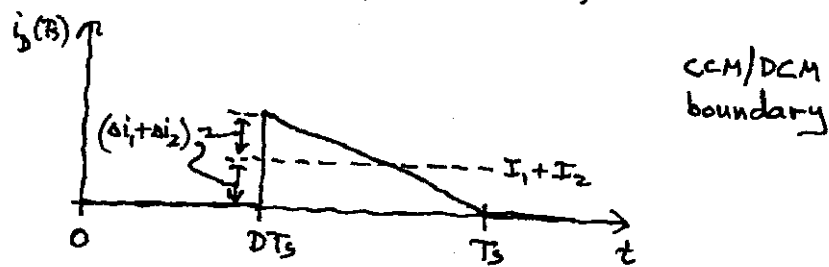

(2)



If we further increase  $R$ , then  $i_D(t)$  will reach zero before the end of the switching period. The diode then becomes reverse-biased, and the converter operates in the discontinuous conduction mode:

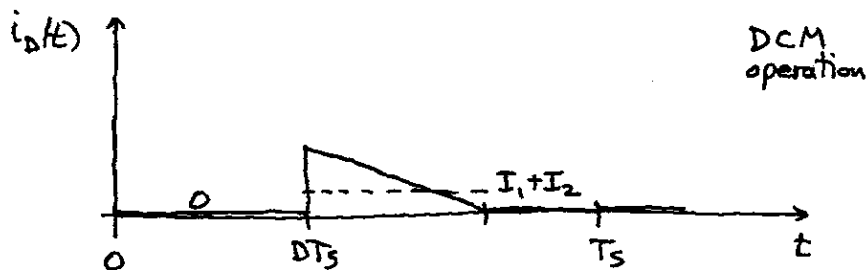

So the Cuk converter operates in DCM when

$$I_1 + I_2 < \Delta i_1 + \Delta i_2$$

Substitute the CCM expressions for  $I_1$ ,  $I_2$ ,  $\Delta i_1$ ,  $\Delta i_2$  (note that the CCM analysis is valid at the CCM/DCM boundary):

$$\left(\frac{D}{D'}\right)^2 \frac{V_g}{R} + \frac{D}{D'} \frac{V_g}{R} < \frac{V_g D T_s}{2L_1} + \frac{V_g D T_s}{2L_2}$$

Rearrange terms:

$$\Rightarrow 2 \frac{L_1 L_2}{R T_s} < (D')^2$$

$$K < K_{crit}(D) \quad \text{for DCM}$$

$$\text{with } K = \frac{2 L_1 L_2}{R T_s}, \quad K_{crit} = (D')^2$$

End of problem 5.5

③

## Solution to Problem 5.6

Conversion ratio analysis of  
the Cuk converter in DCM

R.W. Erickson  
Fundamentals of  
Power Electronics

See solution to problem 5.5 for schematic  
and mode boundary analysis.

a) For the given values, we obtain

$$K = \frac{2 L_1 \parallel L_2}{R T_s} = \frac{(2) (54 \mu\text{H} \parallel 27 \mu\text{H})}{(10 \Omega) (10 \mu\text{s})}$$
$$= 0.36$$

these  
equations  
derived  
in  
Prob. 5.5

$$K_{\text{crit}} = (D')^2 = (1 - 0.4)^2 = 0.36$$

so indeed  $K = K_{\text{crit}}$  and the converter  
operates at the boundary between CCM  
and DCM

We can sketch the current waveforms  
 $i_D(t)$ ,  $i_1(t)$ , and  $i_2(t)$  using the CCM  
analysis of Section 2.4.

①

From Eq. (2.53):

$$I_1 = \left(\frac{D}{D'}\right)^2 \frac{V_g}{R} = \left(\frac{0.4}{0.6}\right)^2 \frac{(120)}{(10)} = 5.33 \text{ A}$$

$$I_2 = \left(\frac{D}{D'}\right) \left(\frac{V_g}{R}\right) = \left(\frac{0.4}{0.6}\right) \left(\frac{120}{10}\right) = 8.0 \text{ A}$$

(Note: polarity of  $I_2$  in Fig. 5.23 is reversed from polarity used in Section 2.4)

From Eq. (2.57):

$$\Delta i_1 = \frac{V_g D T_s}{2L_1} = \frac{(120)(0.4)(10\mu\text{s})}{(2)(54\mu\text{H})} = 4.44 \text{ A}$$

$$\Delta i_2 = \frac{V_g D T_s}{2L_2} = \frac{(120)(0.4)(10\mu\text{s})}{(2)(27\mu\text{H})} = 8.88 \text{ A}$$

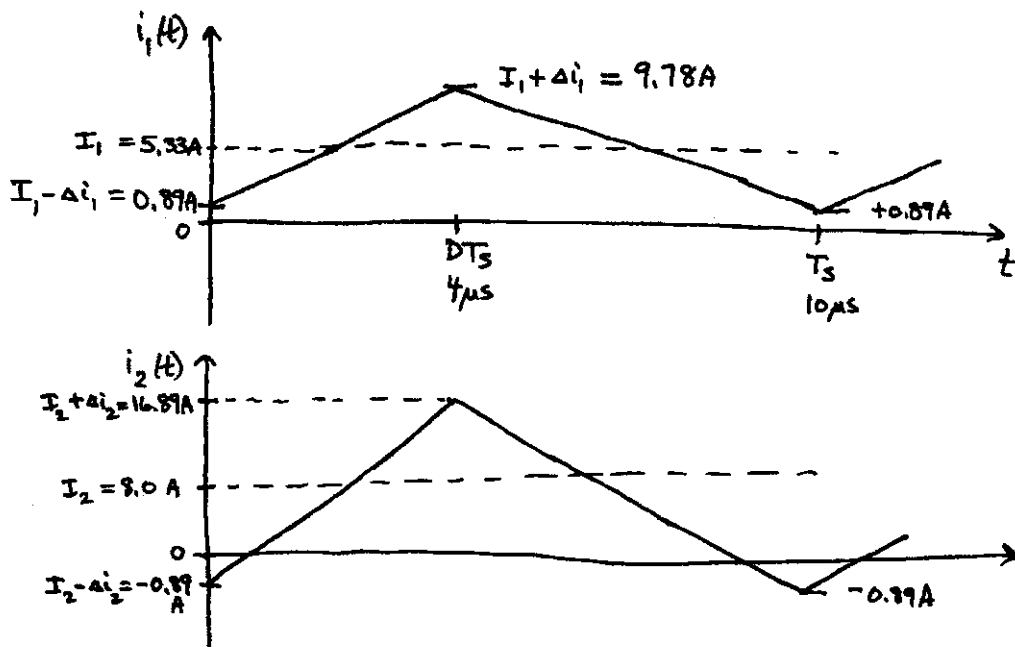

note  $i_2(0) < 0$  and  $\Delta i_2 > I_2$

(2)

Diode current waveform

$$i_D(t) = \begin{cases} 0 & \text{during } 0 < t < DT_s \\ i_1(t) + i_2(t) & \text{during } DT_s < t < T_s \end{cases}$$

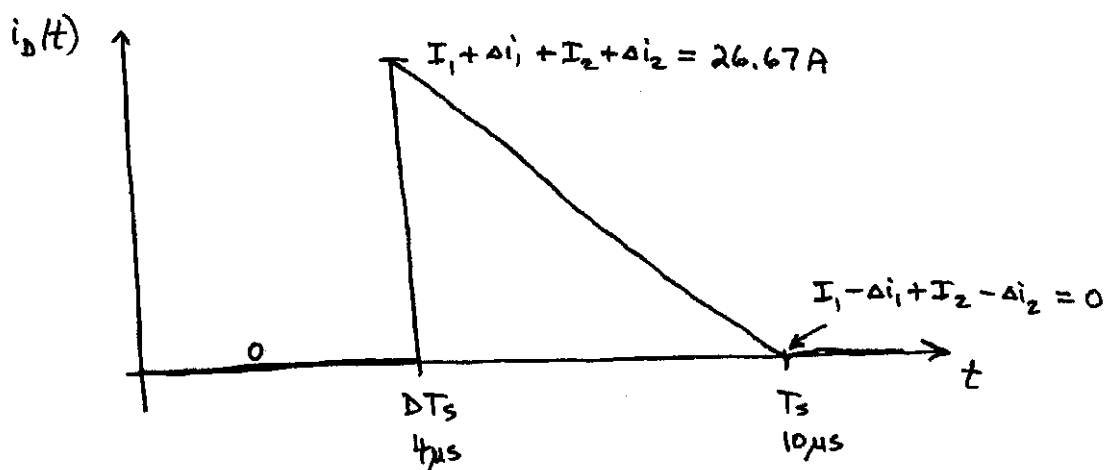

Note  $i_D(T_s) = 0$  (for this operating point at the CCM/DCM boundary)

Note that  $i_D(T_s) = 0$  does not necessarily imply that  $i_1(T_s) = 0$  and  $i_2(T_s) = 0$ ! Rather, it implies that  $i_1(T_s) = -i_2(T_s)$ .

③

If the load resistance is increased, then the dc currents  $I_1$  and  $I_2$  are decreased. The converter enters the discontinuous conduction mode, with the following waveforms:

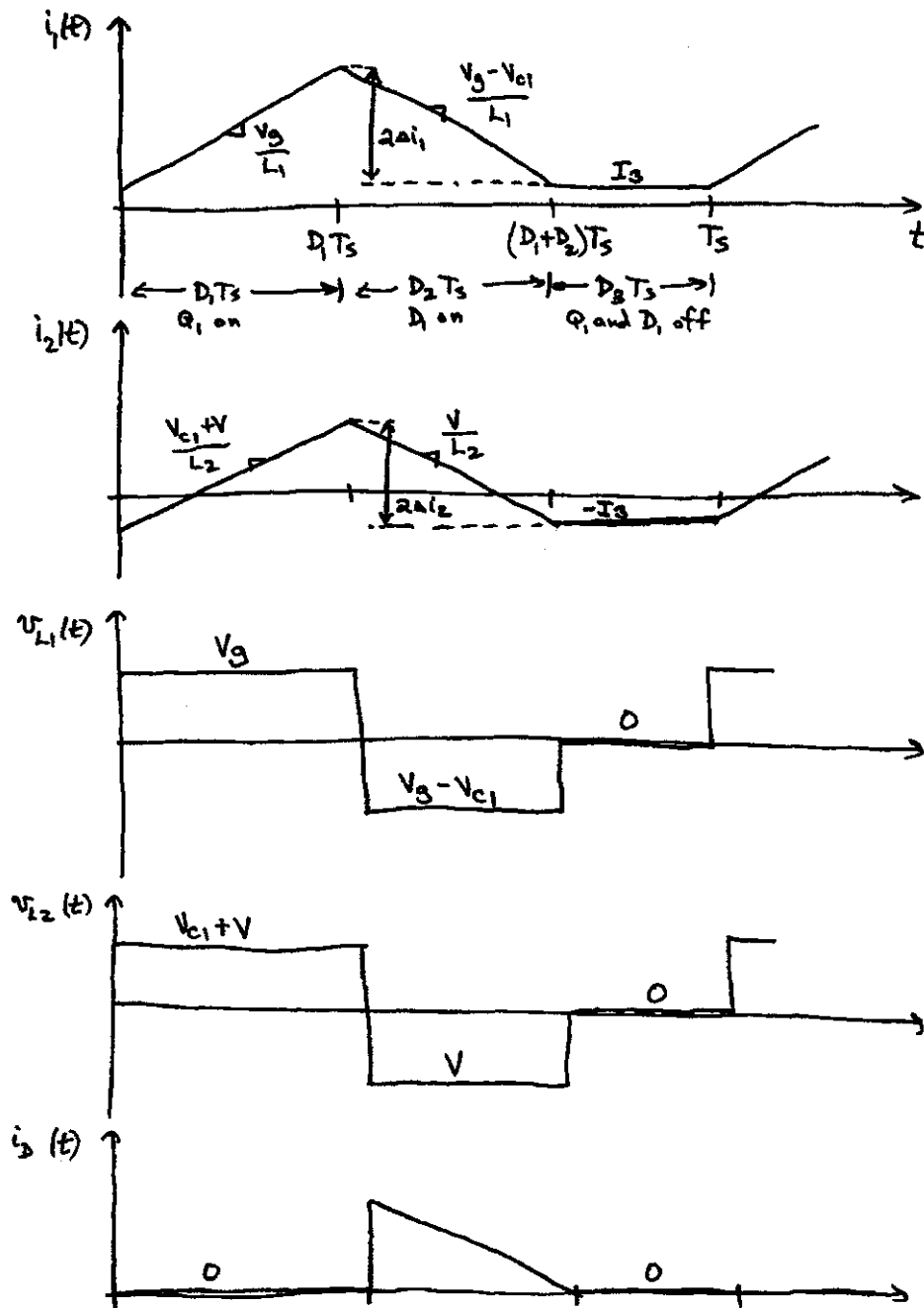

(solution to part c)

b) Solution of DC conversion ratio  $M(D_1, K)$  in DCM

Volt-second balance on  $L_1$  and  $L_2$ :

$$\langle v_{L1} \rangle = D_1 V_g + D_2 (V_g - V_{c1}) = 0$$

$$\langle v_{L2} \rangle = D_1 (V_{c1} + V) + D_2 (V) = 0$$

Charge balance on  $C_2$ :

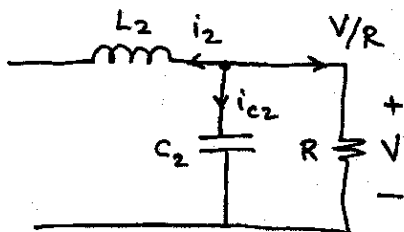

Dc component  $\langle i_{c2} \rangle = 0$

Therefore, the dc load current  $-\frac{V}{R}$  is

equal to the dc component of inductor current

$$\langle i_2 \rangle = I_2$$

$$I_2 = -\frac{V}{R}$$

Must compute  $I_2 = \langle i_2 \rangle$ . Inductor current waveform from previous page:

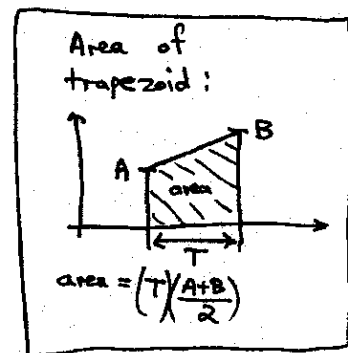
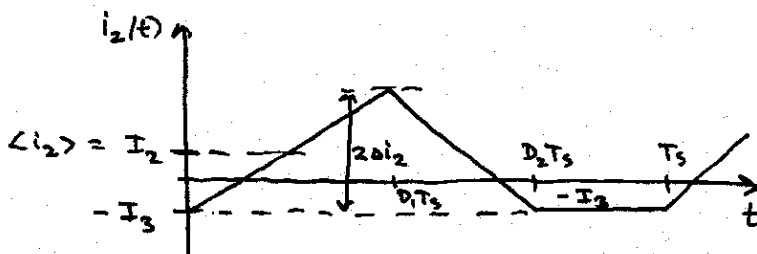

$$\langle i_2 \rangle = \frac{1}{T} \int_0^T i_2(t) dt = \frac{1}{T} \cdot \left[ (D_1 T_s) \frac{(-I_3) + (-I_3 + 2\Delta i_2)}{2} + (D_2 T_s) \frac{(-I_3) + (-I_3 + 2\Delta i_2)}{2} + (D_3 T_s) (-I_3) \right]$$

note  $D_1 + D_2 + D_3 = 1$

simplify :

$$I_2 = -I_3 + (D_1 + D_2) \Delta i_2$$

so

$$-I_3 + (D_1 + D_2) \Delta i_2 = -\frac{V}{R}$$

$$\text{with } \Delta i_2 = \frac{V_{c1} + V}{2L_2} D_1 T_s$$

Charge balance on  $C_1$  :

$$i_{c1}(t) = \begin{cases} -i_2(t) & \text{during } 0 < t < D_1 T_s \\ i_1(t) & \text{during } D_1 T_s < t < (D_1 + D_2) T_s \\ i_1(t) (= -i_2(t) = I_3) & \text{during } (D_1 + D_2) T_s < t < T_s \end{cases}$$

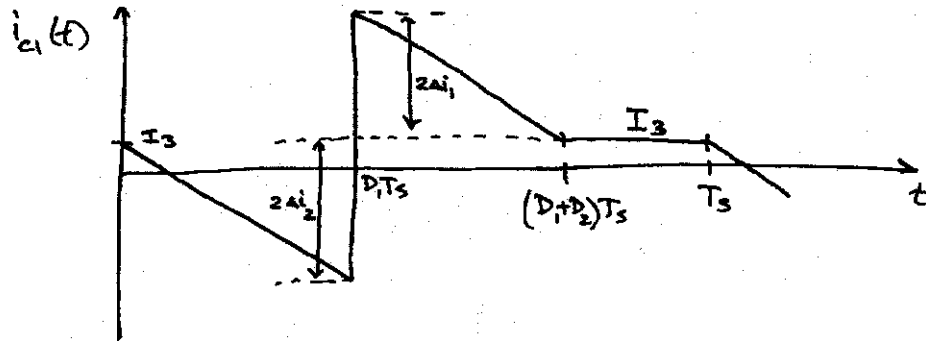

capacitor charge balance:

$$\langle i_{c1} \rangle = 0 = \frac{1}{T_s} \int_0^{T_s} i_{c1}(t) dt = \frac{1}{T_s} \left[ D_1 T_s \frac{I_3 + (I_3 - 2\Delta i_2)}{2} + D_2 T_s \frac{(I_3 + 2\Delta i_1) + I_3}{2} + D_3 T_s I_3 \right]$$

(6)

Simplify :

$$0 = I_3 - D_1 \Delta i_2 + D_2 \Delta i_1$$

Summary of DCM equations :

$$(i) \quad 0 = (D_1 + D_2) V_g - D_2 V_{c1} \quad (\text{volt-sec balance on } L_1)$$

$$(ii) \quad 0 = (D_1 + D_2) V + D_1 V_{c1} \quad (\text{volt-sec balance on } L_2)$$

$$(iii) \quad -I_3 + (D_1 + D_2) \Delta i_2 = -\frac{V}{R} \quad (\text{charge balance on } C_2)$$

$$(iv) \quad 0 = I_3 - D_1 \Delta i_2 + D_2 \Delta i_1 \quad (\text{charge balance on } C_1)$$

$$\text{with } \Delta i_1 = \frac{V_g}{2L_1} D_1 T_s \quad (v)$$

$$\Delta i_2 = \frac{V_{c1} + V}{2L_2} D_1 T_s \quad (vi) \quad (\text{expressions for inductor current ripples})$$

Algebra: solve for  $M = \frac{V}{V_g}$

$$\text{from (i): } V_{c1} = \frac{D_1 + D_2}{D_2} V_g$$

$$\text{from (ii): } V = -\frac{D_1}{D_1 + D_2} V_{c1} = -\frac{D_1}{D_2} V_g \Rightarrow M = \frac{V}{V_g} = -\frac{D_1}{D_2}$$

Eliminate  $I_3$  from (iii) and (iv):

$$I_3 = (D_1 + D_2) \Delta i_2 + \frac{V}{R} = D_1 \Delta i_2 - D_2 \Delta i_1$$

Solve for  $D_2$ :

$$D_2 (\Delta i_1 + \Delta i_2) = -\frac{V}{R} \Rightarrow D_2 = -\frac{V}{R} \frac{1}{\Delta i_1 + \Delta i_2}$$

(7)



substitute (v) and (vi):

$$D_2 = -\frac{V}{R} \frac{1}{(D_1 T_3) \left( \frac{V_3}{2L_1} + \frac{V_{c1} + V}{2L_2} \right)} = -\frac{V}{RD_1 T_3} \frac{2}{\frac{V_3}{L_1} + \frac{V_3}{L_2}}$$
$$= -\frac{V}{V_3} \frac{2L_1 L_2}{D_1 R T_3} \Rightarrow D_2 = -\frac{MK}{D_1}$$

Now substitute this expression for  $D_2$  into the previous expression for  $M$ :

$$M = -\frac{D_1}{D_2} = -\frac{D_1}{\left(-\frac{MK}{D_1}\right)}$$

← note that, since  $D_1$  and  $D_2$  are positive,  $M$  must be negative

solve for  $M(D_1, K)$ :

$$M^2 = \frac{D_1^2}{K} \Rightarrow M(D_1, K) = \pm \frac{D_1}{\sqrt{K}} \quad \text{select minus sign}$$

$$M(D_1, K) = -\frac{D_1}{\sqrt{K}}$$

c) see page (4)

(8)

# EE445/EE545

## FORWARD CONVERTER HW

Steady-state analysis of the forward converter

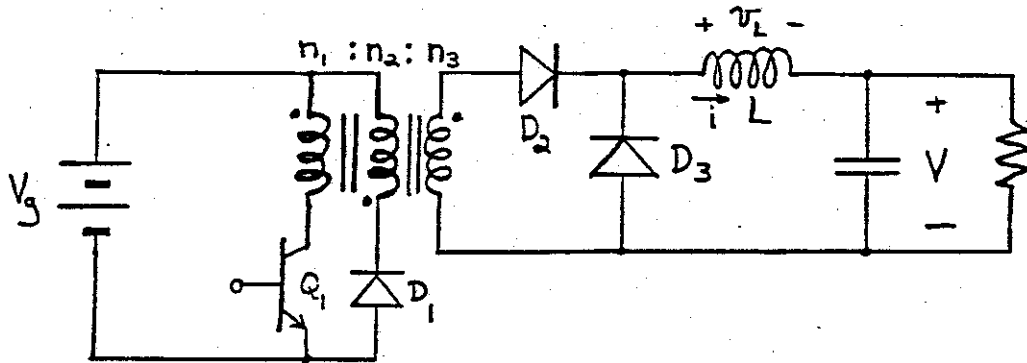

The forward converter is a modification of the buck converter which incorporates an isolation transformer. It is often used in off-line applications.

Assume that the three-winding transformer can be modelled by a mutual inductance  $L_M$  and an ideal three-winding transformer, as below:

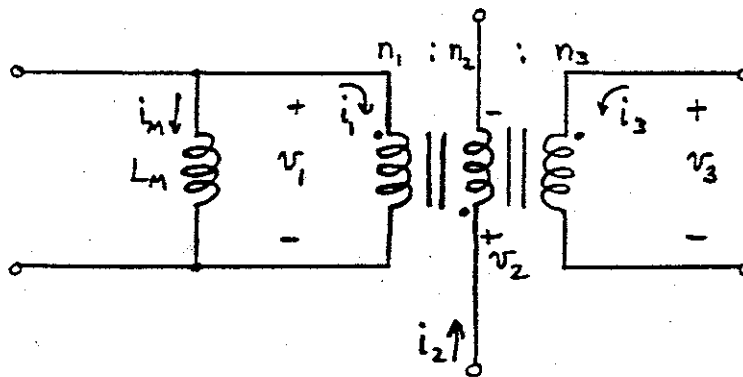

$$n_1 i_1 + n_2 i_2 + n_3 i_3 = 0$$

$$\frac{v_1}{n_1} = \frac{v_2}{n_2} = \frac{v_3}{n_3}$$

Thus, the converter effectively contains two inductors:  $L$  and  $L_M$ .  $L_M$  is always operated in discontinuous conduction mode, while  $L$  usually operates in continuous conduction mode. Hence, the switch conduction sequence is:

interval:	$D_1 T_s$	$D_2 T_s$	$D_3 T_s$
conducting switches:	$Q_1, D_2$	$D_1, D_3$	$D_3$

1. Determine the dc conversion ratio  $V/V_g$
2. It is desired to use this converter in the following off-line application:

$$V_g = 150 \text{ volts}$$

$$f_s = 25 \text{ kHz}$$

$$V = 5 \text{ volts}$$

$$P_{\text{out}} = 150 \text{ watts}$$

Use  $n_1 = n_2 = 10 n_3$ .

Determine the duty ratio  $D_1$ , and the value of  $L$  for which the peak-to-average current ripple  $\Delta i$  is 10% of the average inductor current  $I_0$ .

3. Sketch the waveforms for  $i_M(t)$ ,  $v_1(t)$ ,  $i(t)$ , and  $V_L(t)$ . Label salient features.
4. What are the transistor voltage and current stresses?
5. Over what range of duty ratios ( $D_1$ ) do the volt-seconds on  $L_M$  balance to zero? How is your answer changed when  $n_1 \neq n_2$ ?

# SOLUTION

EE445/S45

## FORWARD CONVERTER

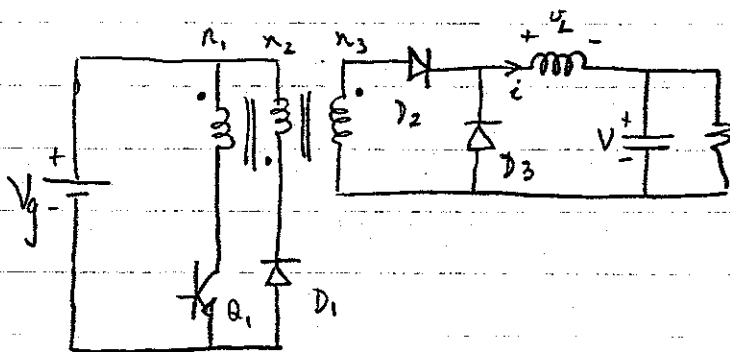

Fig 1

Replacing the transformer with its model and drawing the three topologies which result from the following switch sequence.

INTERVAL	$D_1 T_s$	$D_2 T_s$	$D_3 T_s$
CONDUCTING SWITCHES	$Q_1, D_2$	$D_1, D_3$	$D_3$

we have the following.

DURING  $D_1 T_s$

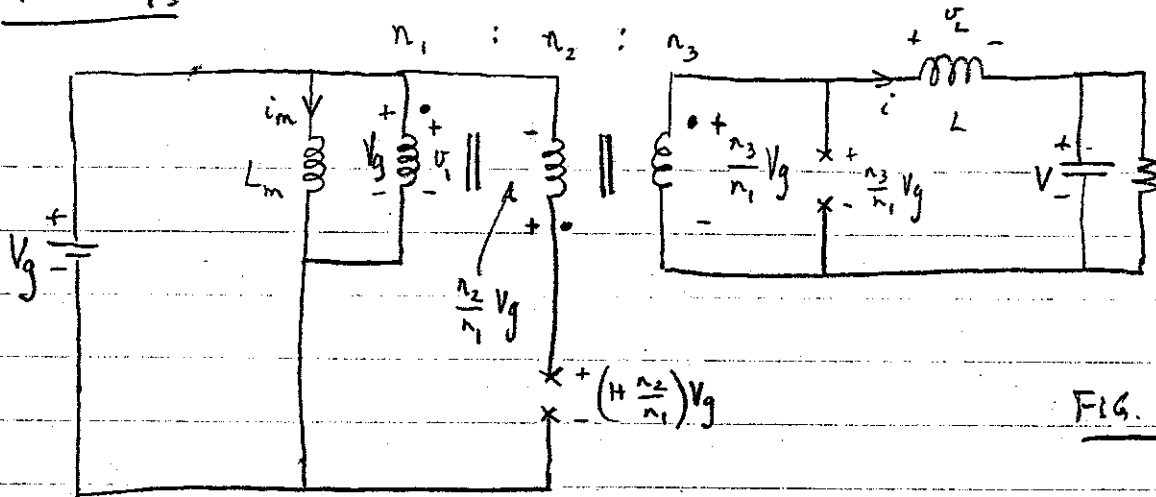

FIG. 2A

DURING  $D_2 T_s$

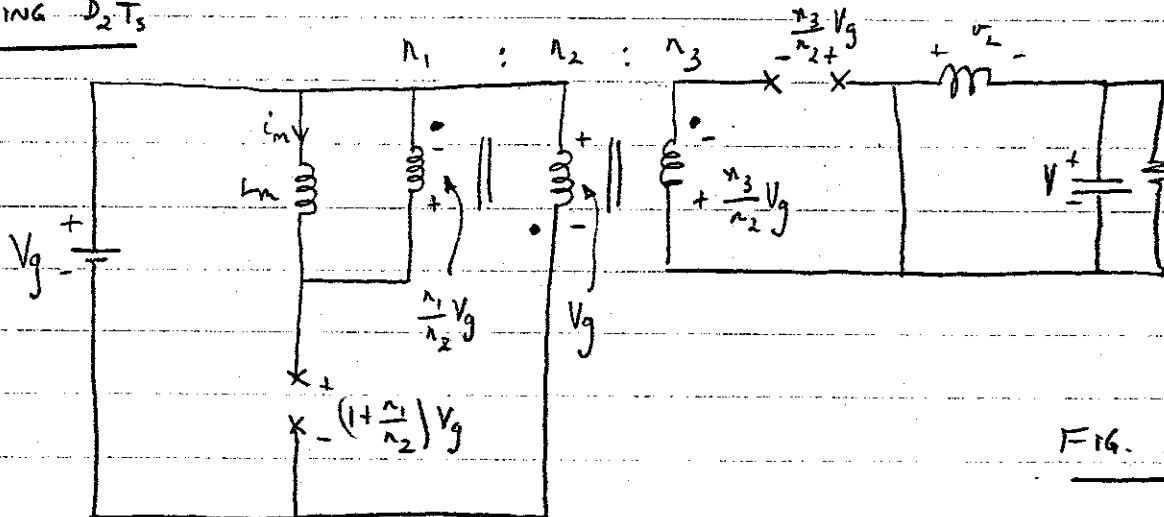

FIG. 2B

DURING  $D_3 T_s$

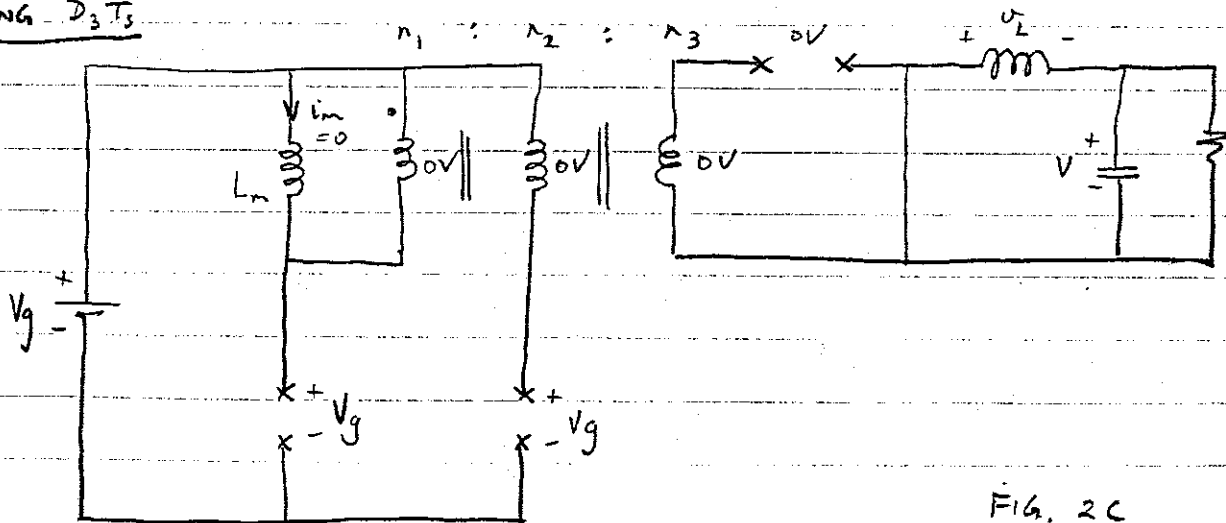

FIG. 2C

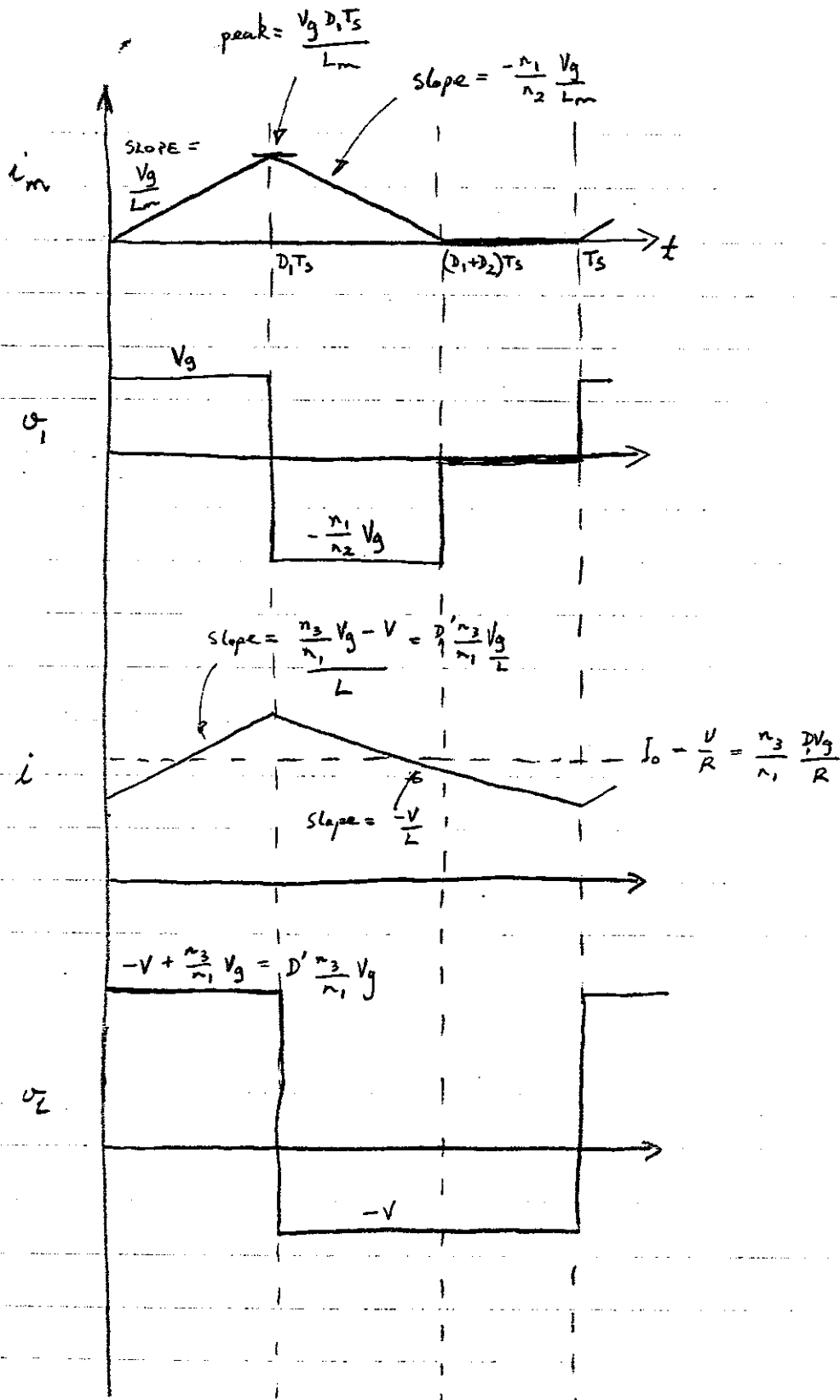

FIG. 3

1. Determine  $V/V_g$ :

By volt-sec balance considerations on  $L$  we have

$$\left(-V + \frac{n_3}{n_1} V_g\right) D_1 = V D_1' \quad \text{where } D_1' = 1 - D_1$$

$$\Rightarrow \boxed{V = \frac{n_3}{n_1} D_1 V_g}$$

2.  $V_g = 150$  ;  $V = 5$  ;  $P_{out} = 150$  ;  $n_1 = n_2 = 10 n_3$

Determine  $D_1$  :  $D_1 = \frac{n_1}{n_3} \frac{V}{V_g}$

$$\Rightarrow D_1 = \frac{5 \times 10}{150} = 0.3333$$

Determine  $L$  : Now  $P_{out} = \frac{V^2}{R} \Rightarrow R = \frac{V^2}{P_{out}}$

$$\Rightarrow R = \frac{(5)^2}{150} = 0.16667 \Omega$$

Now  $\Delta i = 0.1 I_0$  (by design)

$$\Delta i = \frac{n_3}{n_1} \frac{V_g}{L} \frac{D_1' D_1 T_s}{2}$$

$$I_0 = \frac{n_3}{n_1} \frac{D_1 V_g}{R}$$

$\Rightarrow$

- 5 -

$$L = \frac{D_1 T_3 R}{0.2}$$

$$\Rightarrow L = \frac{0.6667 \times 0.1667}{25 \times 10^3 \times 0.2}$$

$$= 22 \mu\text{H}$$

4) From Fig. 2 we see the maximum voltage stresses

are

DEVICE	VOLTAGE STRESS
$Q_1$	$(1 + \frac{n_1}{n_2}) V_g$
$D_1$	$(1 + \frac{n_2}{n_1}) V_g$
$D_2$	$\frac{n_3}{n_2} V_g$
$D_3$	$\frac{n_3}{n_1} V_g$

The evaluation of the current stress are a little more involved.

Current stress in  $Q_1$

The current in  $Q_2$  has two components

- 1) magnetizing current in transformer
- 2) reflected current in  $L$



The maximum current stress can be seen from Fig. 3 to occur at the end of  $D_1 T_s$ .

$$\Rightarrow I_{a2\text{MAX}} = \frac{V_g D_1 T_s}{L_m} + \frac{n_3}{n_1} \left[ \frac{n_3 D_1 V_g}{n_1 R} + D_1' \frac{n_3}{n_1} \frac{V_g}{L} \frac{D_1 T_s}{2} \right]$$

$$I_{a2\text{MAX}} = \frac{V_g D_1 T_s}{L_m} + \left( \frac{n_3}{n_1} \right)^2 \frac{D_1 V_g}{R} \left[ 1 + \frac{D_1' T_s R}{2L} \right]$$

### CURRENT STRESS IN DIODE $D_1$

From Fig. 2 and Fig 3 we can appreciate that the maximum current stress in  $D_1$  occurs at the beginning of  $D_2 T_s$ .

$$\Rightarrow I_{D1\text{MAX}} = \frac{n_1}{n_2} \frac{V_g D_1 T_s}{L_m}$$

### CURRENT STRESS IN $D_2$ AND $D_3$

From Fig 3 we see that the maximum current stress in diodes  $D_2$  and  $D_3$  occur at the end of  $D_1 T_s$  and at the beginning of  $D_2 T_s$ , respectively.

$$I_{D2\text{MAX}} = I_{D3\text{MAX}} = \frac{n_3 D_1 V_g}{n_1 R} + D_1' \frac{n_3}{n_1} \frac{V_g}{L} \frac{D_1 T_s}{2} = \frac{n_3 D_1 V_g}{n_1 R} \left[ 1 + \frac{D_1' T_s R}{2L} \right]$$

- 7 -

5. For volt-sec. balance we require

+ve volt-sec  $\leq$  max. -ve volt-sec

$$\Rightarrow D_1 V_g \leq \max_{D_3} \left\{ \frac{n_1}{n_2} V_g (1 - D_1 - D_3) \right\}$$

max. occurs at  $D_3 = 0$

$$\Rightarrow D_1 V_g \leq \frac{n_1}{n_2} V_g (1 - D_1)$$

$$\Rightarrow D_1 \left( 1 + \frac{n_1}{n_2} \right) \leq \frac{n_1}{n_2}$$

$$\Rightarrow \boxed{D_1 \leq \frac{n_1}{n_1 + n_2}}$$

$\therefore$  for  $n_1 = n_2 \Rightarrow D_1 \leq 0.5$

## EE410PE MIDTERM

(10 marks) PROBLEM 1.

a) Using the voltage-current equation for an inductor, show that the average voltage per switching period,  $T_s$ , across an inductor in a PWM converter operating in steady state is zero.

(15 marks) PROBLEM 2.

For the following, express your results in terms of the relevant *known* quantities  $V_g$ ,  $D$ ,  $T_s$  and the component values  $L_1$ ,  $L_2$ ,  $C_1$ ,  $C_2$  and  $R$ .

Determine for the PWM converter of Fig. 1 (known as the SEPIC converter) operating in steady-state in the continuous conduction mode (CCM) the following:

- (5) a) the peak current experienced by the transistor
- (5) b) the peak voltage experienced by the transistor. Be sure to take into consideration the voltage ripple on  $C_1$  but neglect the ripple on  $C_2$ .
- (5) c) Using your results of a) and b), sketch the waveform of the transistor current for two switching cycles and below it, clearly showing the timing relationship, sketch the waveform of the transistor (collector-emitter) voltage. Label salient features on your sketch, such as the values at the top and bottom of slopes and the time scale.

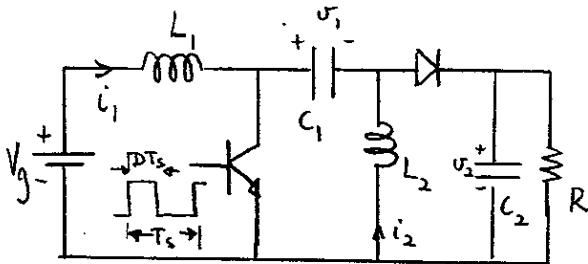

Fig. 1

(15 marks) **PROBLEM 3.**

Derive an equivalent circuit model of the PWM boost converter of Fig. 2, which models the DC properties of the converter operating in the continuous conduction mode (CCM). Your model should take into consideration the non-ideality of the transistor switch,  $Q$ , which is to be modelled as a (small-valued) finite resistance  $r_{ON}$ , in its ON state, and a finite resistance  $r_{OFF}$  ( $\gg r_{ON}$ ) in its OFF state. All other components may be assumed to be ideal.

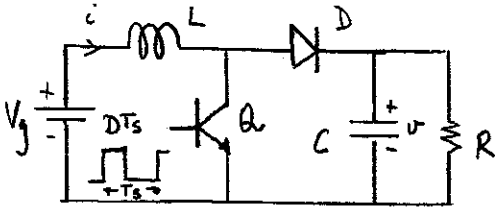

Fig. 2

(15 marks) PROBLEM 4.

Derive an expression for the peak-to-peak output voltage ripple for the buck converter of Fig. 3 for operation in the continuous conduction mode (CCM). Be sure to express your answer in terms of all relevant *known* quantities.

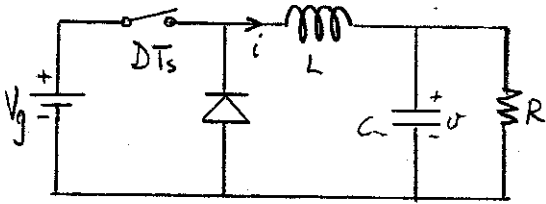

Fig. 3

SOLUTION

EE4107E

MIDTERM

Problem 1:

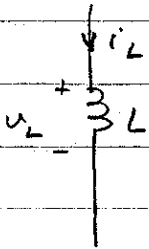

$$v_L = L \frac{di_L}{dt}$$

$$\langle v_L \rangle = \frac{1}{T_s} \int_0^{T_s} v_L(t) dt$$

$$= \frac{1}{T_s} \int_0^{T_s} L \frac{di_L}{dt} dt$$

$$= \frac{L}{T_s} \int_0^{T_s} di_L$$

$$= \frac{L}{T_s} [i_L(T_s) - i_L(0)]$$

In steady state  $i_L(T_s) = i_L(0)$

$$\Rightarrow \langle v_L \rangle = 0$$

Problem 2

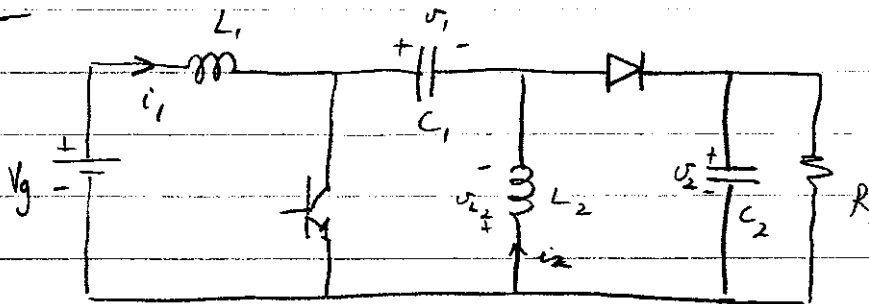

$V_1 = V_g$  (since zero average voltage across  $L_1 + L_2$ )

Volt-sec on  $L_2$   $\Rightarrow$

$D V_g - D' V_2 = 0 \Rightarrow V_2 = \frac{D}{D'} V_g$

$\Rightarrow$  Output current =  $\frac{D}{D'} \frac{V_g}{R}$

$\Rightarrow$  average current in  $L_2 = I_2 = \frac{D}{D'} \frac{V_g}{R}$  since average current in  $C_1 = 0$

average current in  $L_1$  :  $P_{in} = P_{out}$   
 $\Rightarrow V_g I_1 = \left(\frac{D}{D'} V_g\right)^2 \frac{1}{R}$   
 $\Rightarrow I_1 = \left(\frac{D}{D'}\right)^2 \frac{V_g}{R}$

Peak-peak current in  $L_1 = \Delta i_1$   
 $= \frac{V_g D T_s}{L_1}$

peak-peak current in  $L_2 = \Delta i_2$   
 $= \frac{V_g D T_s}{L_2}$



ALTERNATIVELY

Using charge balance to find  $I_1$  +  $I_2$

$$\underline{C_1}: \underline{\frac{D}{D'}} i_{C_1} = -i_2$$

$$\frac{D'}{D} i_{C_1} = i_1$$

$$\Rightarrow -DI_2 + D'I_1 = 0$$

$$\Rightarrow I_1 = + \frac{DI_2}{D'}$$

$$\underline{C_2}: \underline{\frac{D}{D'}} i_{C_2} = \frac{-V_2}{R}$$

$$\frac{D'}{D} i_{C_2} = i_1 + i_2 - \frac{V_2}{R}$$

$$\Rightarrow \frac{-DV_2}{R} + D'I_1 + D'I_2 - \frac{D'V_2}{R} = 0$$

$$\Rightarrow D'(I_1 + I_2) = \frac{V_2}{R}$$

$$\Rightarrow D' \left( \frac{DI_2}{D'} + I_2 \right) = \frac{V_2}{R}$$

$$\Rightarrow I_2 D' \left( \frac{D+D'}{D'} \right) = \frac{V_2}{R}$$

$$\Rightarrow I_2 = \frac{V_2}{R} = \frac{D}{D'} \frac{V_2}{R}$$

$$\Rightarrow I_1 = \frac{D}{D'} \frac{V_2}{R} = \left( \frac{D}{D'} \right)^2 \frac{V_2}{R}$$

a) peak current in transistor =  $I_1 + I_2 + \frac{\Delta i_1}{2} + \frac{\Delta i_2}{2}$

$$= \left(\frac{D}{D'}\right)^2 \frac{V_g}{R} + \frac{DV_g}{D'R} + \frac{V_g DT_s}{2L_1} + \frac{V_g DT_s}{2L_2}$$

$$= \frac{DV_g}{D^2 R} + \left(\frac{1}{L_1} + \frac{1}{L_2}\right) \frac{V_g DT_s}{2}$$

b) peak transistor voltage =  $V_1 + V_2 + \frac{\Delta V_1}{2} + \frac{\Delta V_2}{2}$

neglect  $\Delta V_2$ ;

$$V_1 = V_g$$

$$V_2 = \frac{D}{D'} V_g$$

need to find  $\Delta V_1$  :

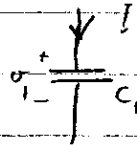

$$i = C \frac{dv}{dt}$$

$$\Rightarrow \Delta V_1 = \frac{I_1 DT_s}{C_1}$$

$$\Rightarrow \text{peak transistor voltage} = V_g + \frac{D}{D'} V_g + \frac{I_1 DT_s}{2C_1}$$

$$= \frac{V_g}{D'} + \frac{D^2}{D'} \frac{V_g T_s}{2RC_1}$$

$$\frac{\Delta V_o}{D'^2 R} - \left(\frac{1}{L_1} + \frac{1}{L_2}\right) \frac{V_g D T_s}{2} \approx I_1 + I_2$$

$$I_1 + I_2 + \frac{\Delta i_1}{2} + \frac{\Delta i_2}{2} = \frac{\Delta V_o}{D'^2 R} + \left(\frac{1}{L_1} + \frac{1}{L_2}\right) \frac{V_g D T_s}{2}$$

c)

$i_c$

$V_{CE}$

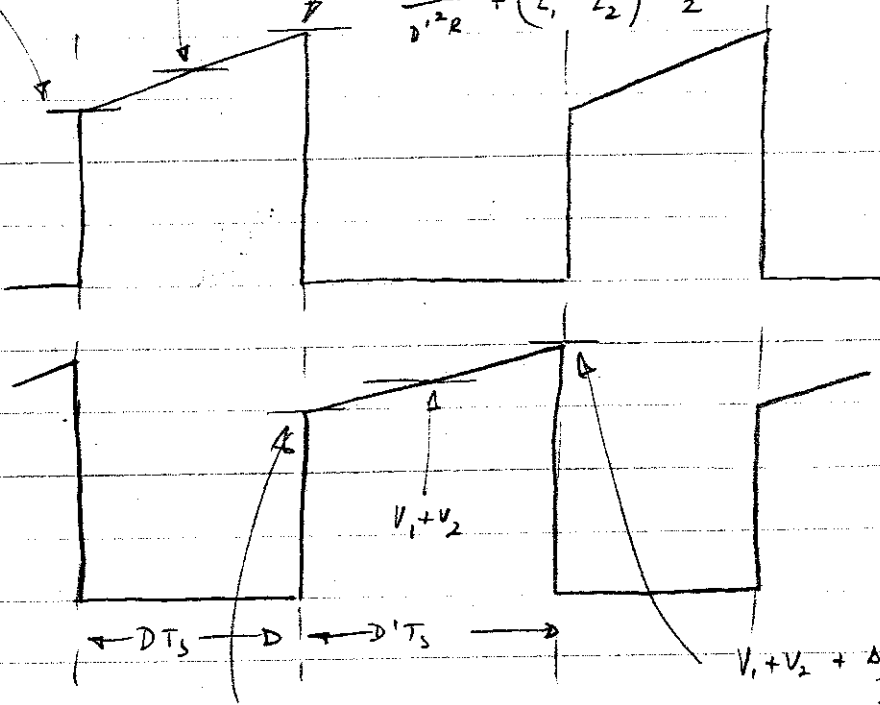

$$\frac{V_g}{D'} - \frac{D^2}{D'} \frac{V_g T_s}{2RC_1}$$

$$= \frac{V_g}{D'} + \frac{D^2}{D'} \frac{V_g T_s}{2RC_1}$$

Problem 3

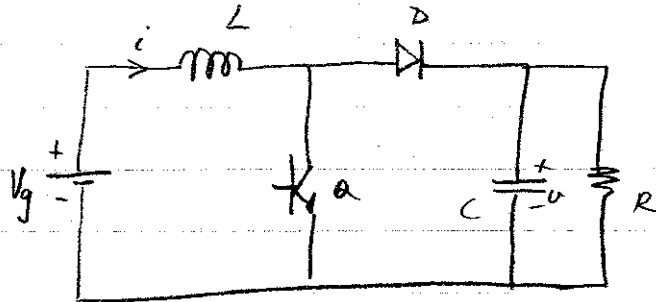

DTs:

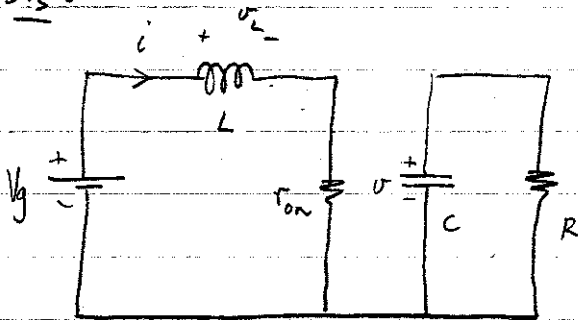

D'Ts:

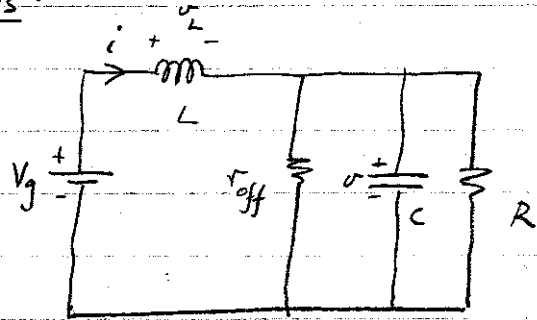

$$v_L = V_g - i r_{on}$$

$$v_L = V_g - v$$

$$i_C = -\frac{v}{R}$$

$$i_C = i - \frac{v}{r_{off}} - \frac{v}{R}$$

Inductor Volt-sec. balance:

$$\Rightarrow D(V_g - i r_{on}) + D'(V_g - v) = 0$$

$$\Rightarrow V_g - D I r_{on} - D' v = 0 \quad (1)$$

Capacitor charge balance:

$$\Rightarrow -D \frac{v}{R} + D' I - \frac{D' v}{r_{off}} - \frac{D' v}{R} = 0$$

$$\Rightarrow D' I = \frac{v}{R} + \frac{D' v}{r_{off}} \quad (2)$$

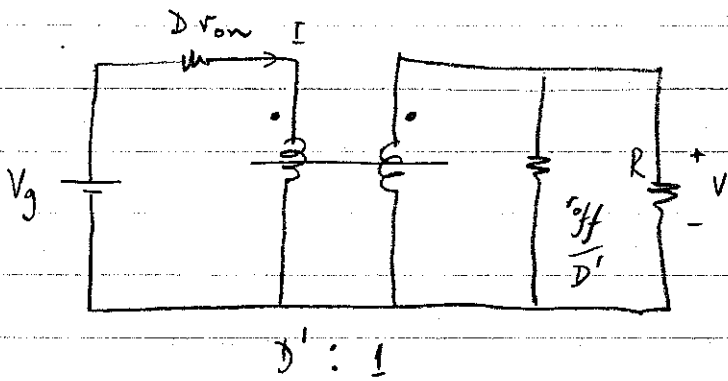
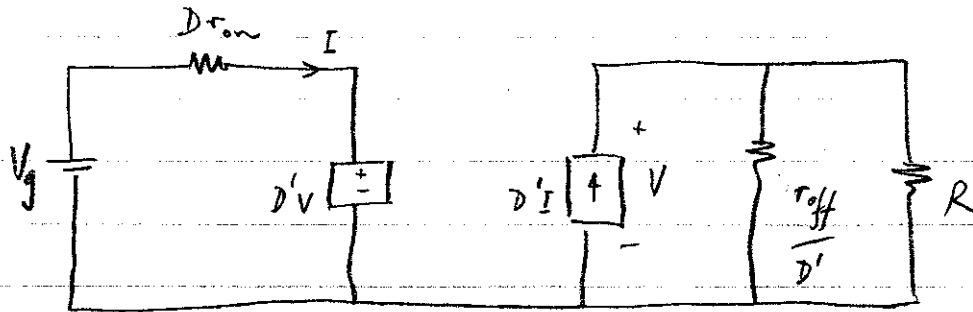

PROBLEM 4 : METHOD 1

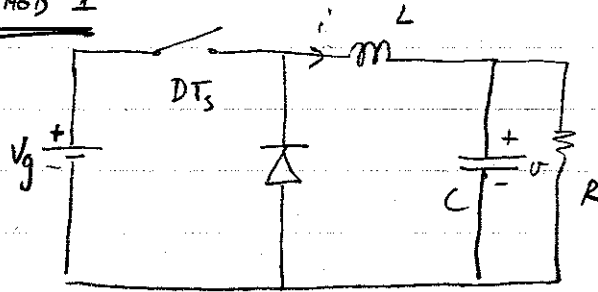

DTs

D'Ts

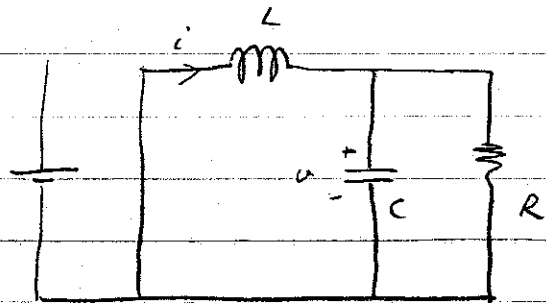
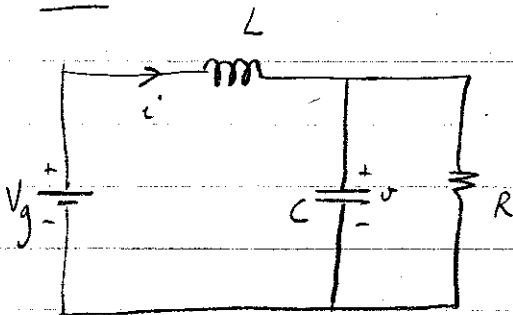

$$-V_g + Li + v = 0 \Rightarrow i = -\frac{v}{L} + \frac{V_g}{L}$$

$$C\dot{v} = i - \frac{v}{R} \Rightarrow \dot{v} = \frac{i}{C} - \frac{v}{RC}$$

The state eqns. are the same as for DTs except  $V_g = 0$

$$\frac{d}{dt} \begin{bmatrix} i \\ v \end{bmatrix} = \underbrace{\begin{bmatrix} 0 & -\frac{1}{L} \\ \frac{1}{C} & -\frac{1}{RC} \end{bmatrix}}_{A_1} \begin{bmatrix} i \\ v \end{bmatrix} + \underbrace{\begin{bmatrix} \frac{1}{L} \\ 0 \end{bmatrix}}_{b_1} V_g$$

$$A_1 = A_2 ; \quad b_1 = \begin{bmatrix} 0 \\ 0 \end{bmatrix}$$

$$\Delta x = (A_1 x + b_1 V_g) DT_s$$

$$\text{now } X = \begin{bmatrix} I \\ V \end{bmatrix} = \begin{bmatrix} \frac{DV_g}{R} \\ DV_g \end{bmatrix} \quad \left( X = -A^{-1} b V_g \right)$$

- 9 -

$$\Rightarrow \Delta x = \left( \begin{bmatrix} 0 & \frac{1}{L} \\ \frac{1}{C} & -\frac{1}{RC} \end{bmatrix} \begin{bmatrix} \frac{DV_g}{R} \\ DV_g \end{bmatrix} + \begin{bmatrix} \frac{1}{L} \\ 0 \end{bmatrix} V_g \right) DT_s$$

$$\Rightarrow \Delta x = \begin{bmatrix} -\frac{DV_g}{L} + \frac{V_g}{L} \\ \frac{DV_g}{RC} - \frac{DV_g}{RC} \end{bmatrix} DT_s$$

$$= \begin{bmatrix} \frac{D'V_g}{L} DT_s \\ 0 \end{bmatrix}$$

$$\Rightarrow \Delta v = 0$$

→ need to find the second order component  $x^{(2)}$

$$\text{now } \Delta^{(2)} x = \frac{A \Delta x T_s}{8}$$

$$\Rightarrow \Delta^2 x = \begin{bmatrix} 0 & -\frac{1}{L} \\ \frac{1}{C} & -\frac{1}{RC} \end{bmatrix} \begin{bmatrix} \frac{D'V_g DT_s}{L} \\ 0 \end{bmatrix} \frac{T_s}{8}$$

$$= \begin{bmatrix} 0 \\ \frac{DD'V_g T_s^2}{8LC} \end{bmatrix}$$

→ the peak-to-peak  
output voltage ripple  
=  $\frac{DD'V_g T_s^2}{8LC}$

Problem 4 : METHOD 2

Assume all the inductor ripple goes through the capacitor.

$$\Delta V = \frac{\Delta Q}{C}$$

$$\frac{\Delta i}{2} = \frac{D'V_g T_s}{2L} = \frac{DD'V_g T_s}{2L}$$

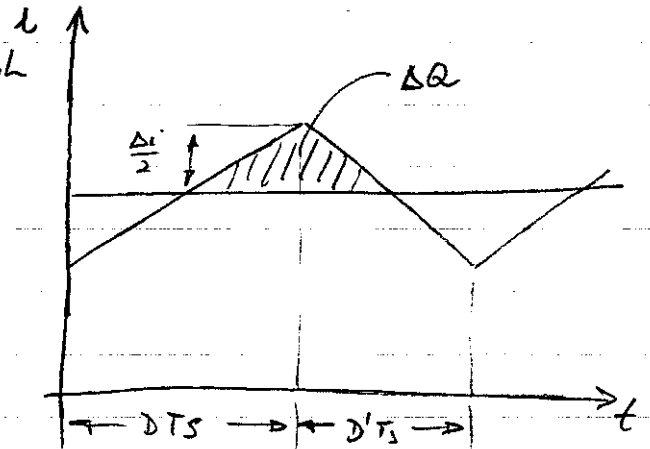

$$\Rightarrow \Delta Q = \frac{1}{2} \left( \frac{DT_s}{2} + \frac{D'T_s}{2} \right) \frac{DD'V_g T_s}{2L}$$

$$= \frac{DD'V_g T_s^2}{8L}$$

$$\Rightarrow \Delta v = \frac{V_g DD'T_s^2}{8LC}$$